

Cylinder pressure sensor

for on-line combustion control

Type 6613CG1/6613CG2

Piezoelectric pressure sensor with galvanic isolated 4 ... 20 mA output signal for continuous cylinder pressure measurement for medium and low speed diesel and gas engines.

- Robust design, with excellent long term stability
- Suitable for knock detection
- Very good thermodynamic behaviour

Description

The shoulder sealed M10×1 sensor and the in-line charge amplifier are connected by a robust Fluorelastomer-cable. The patented "antistrain" design, makes the measuring element insensitive to varying mounting conditions. The Quartz-measuring element is extremely stable and provides a very accurate and repeatable output signal over the whole life time. The sensor has been designed so that a life of several thousand operating hours can be achieved in a diesel and gas engine, but individual sensor life time is strongly depending on application.

Application

Closed loop combustion control and monitoring tasks for e.g. knock detection, cylinder balancing, p_{mi} calculation, etc.

Typ 6613CG1

For 4-stroke engines type 6613CG1 is recommended, this type has a time constant of >10 s, which is fully sufficient for all kind of measurements for 4-stroke engines with >300 1/min.

Typ 6613CG2

This type is especially suitable for 2-stroke engines <300 1/min, the in-line charge amplifier runs with a time constant of >100 s which provides a fully suitable frequency bandwidth for all kind of measuring tasks.

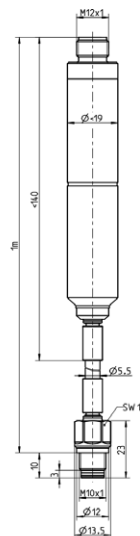

Technical data

Type	6613CG1	6613CG2	
Measuring range	bar	0... 250	0... 250
Sensitivity	mA/bar	0.05	0.05
Overload	bar	300	300
Linearity	% FSO	≤±0.5	
Operating temperature range			
Sensor front	°C	-20... 350	
at cable connection	°C	-20... 200	
at charge amplifier	°C	-20... 120	
Thermal shock at 1 500 1/min, $p_{mi} = 9$ bar	bar	≤±0.5	
Change in sensitivity			
200 ±150 °C	%	≤±2.5	
200 ±50 °C	%	≤±1	
Upper cut-off frequency (-3 dB)	kHz	10	10
Time constant	s	>10	>110
Output current	mA	4... 20	
Signal range	mA	12.5	
Zero line (no pressure)	mA	6.5	
Supply voltage	VDC	18... 32	
Load resistance	Ω	100... 600	
max. voltage*	VDC	500	
Plug DIN (mated)	M12 × 1	IP67	
Weight	g	165	
Tightening torque	N·m	15	
Connector	8 pole	M12 × 1	

* between case, signal output or power supply

Mounting

4-stroke engines

The sensor should be installed close to the combustion chamber. The length of the bore between sensor and combustion chamber depends mainly on the engine speed, a too long bore may generate pipe oscillations disturbing the measuring signal.

An installation at the indicator valve is not recommended for continuous measuring because the operating temperature may exceed the admissible temperature range.

2-stroke engine

The sensor should be installed with patented Kistler adapter Type 7523B ... direct at the cylinder cover. The sensor is flush mounted into the flat pressure canal of the adapter with no pockets or corners. This significantly reduces the build-up of combustion depositon at the sensor membrane.

The indicator valve should be placed right on top of the adapter to minimise the dead volume.

Depending on the amount of combustion residuals the indicator valve should be opened to blow out the combustion residuals from time to time for one single stroke.

For any questions about the installation please contact Kistler.

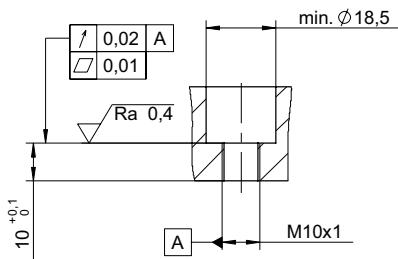

Fig. 1: Mounting bore (4-stroke application) for flush mounting

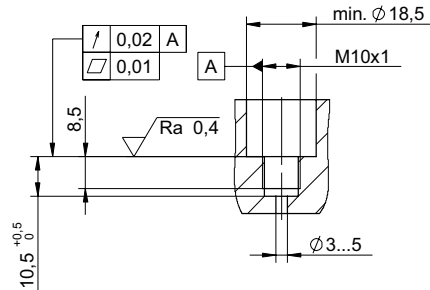

Fig. 2: Mounting bore (4-stroke application) for recessed mounting with additional gas channel. Admissible bore length depends on the application. Too long bore may interfere the quality of the measuring results

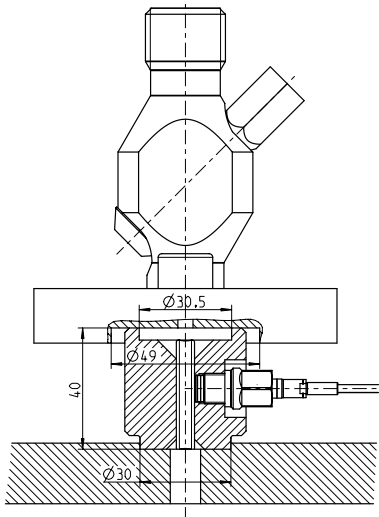

Fig. 3: Mounting with ring adapter Type 7523B10 on MAN 2-stroke engine

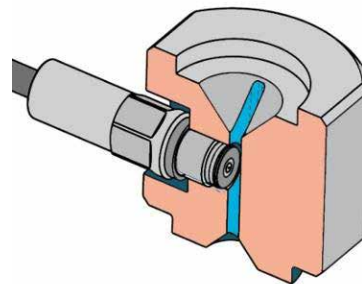

Fig. 4: Schematic view of sensor Type 6613CG... installed in patented ring adapter

6613CG_003 - 043e-06.18

General Specifications

ATEX	II 3G Ex nA IIC T3 Gc
IECEX	IECEX nA IIC T3 Gc
Marine approval	GL, ABS, BV, LR, DNV, CSS

Connector

- 1 **Exct GND**
- 2 don't connect
- 3 don't connect
- 4 don't connect
- 5 **Signal output**
- 6 don't connect
- 7 don't connect
- 8 **+ Exct (18... 32 V)**

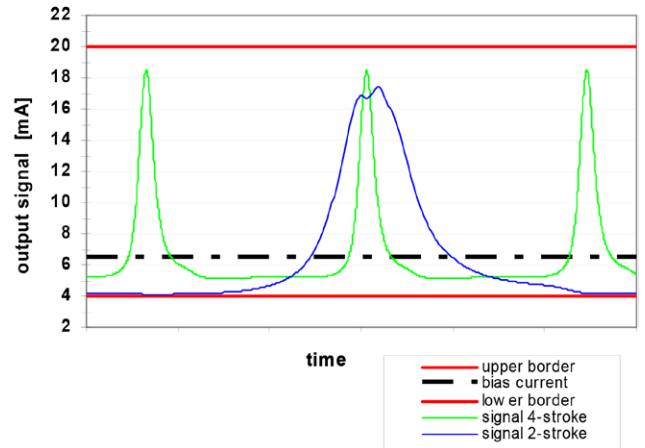
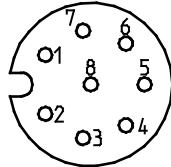
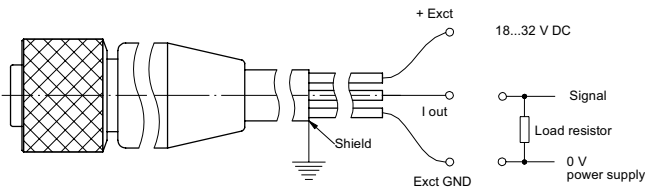

Fig. 5: Example of output signal from 2- and 4-stroke engine with signal span 12.5 mA

Connection of Types 7614CG.../6613CG... to data acquisition system with connecting cable Type 1700B69A...



Important:

Shield must be connected to the case/shield of the data acquisition system (or engine control).
Shield and Exct GND must not be connected!

Optional Accessories

- Torque wrench 8 ... 40 N·m Type/Art. No. 1300A11
- Fork wrench SW 12 for Type 1300A11 1300A13
- Tubular socket 1300B6
- Connecting cable, l = 10 m 1700B69A10
- Connecting cable, l = 20 m 1700B69A20
- Connecting cable, l = 30 m 1700B69A30
- Connecting cable, l = 3 m 1700B69A3
- Connecting cable, l = 1.5 m 1700B69A1,5
- Connecting cable, l = 15 m 1700B69A15
- Adapter for MAN-ME engines* 7523B10
- Adapter for RTA-engines* 7523B11

*dimensions needs to be checked by the customer

Ordering Code

- 4-stroke engine >300 1/min Type 6613CG1
- 2-stroke engine <300 1/min 6613CG2

6613CG_003 - 043e-06.18