

High temperature pressure sensor for glow plug adapter with small diameter

Type 6058A...

Patent No. US 6,105,434

Pressure sensor Type 6058A... is designed specifically for use in glow plug adapters with small diameters where the use of a sensor Type 6058A... is not possible. Sensors with special lengths are not necessary. This greatly simplifies the preparation for combustion analysis measurements and storekeeping.

- Ideal for measurements with glow plug adapter Type 6544Q...
- Good temperature stability of the sensitivity
- Acceleration compensated
- Front diameter $\varnothing 4.0$ mm
- Low thermal shock error and long life due to front seal
- High sensitivity
- Highly miniaturized plug connection (M3 size)

Description

In Type 6058A... the PiezoStar, a new piezoelectric crystal from Kistler is used with which a sensitivity of -17 pC/bar and high thermal stability is achieved. The sensitivity changes by not more than ± 0.5 % over a temperature range of 200 ± 50 °C. The front seal allows good heat dissipation permitting a maximum operating temperature of up to 400 °C for brief duration.

The connector enables pressure sensors of standard length to be installed in varying length glow plug adapters. This distinctly simplifies the preparation for indicating measurements and storekeeping.

Application

The miniature sensor Type 6058A... is used typically in glow plug adapters for pressure measurement in diesel engines (Fig. 3); see also data sheet 6542Q_000-570.

However, due to its small dimensions, it can also be used in engines with complex structural geometries in indicating bores.

The rugged, turned diaphragm also allows measurements beyond the knocking limit; at the same time, thanks to its low thermal shock error, very accurate thermodynamic investigations are still assured.

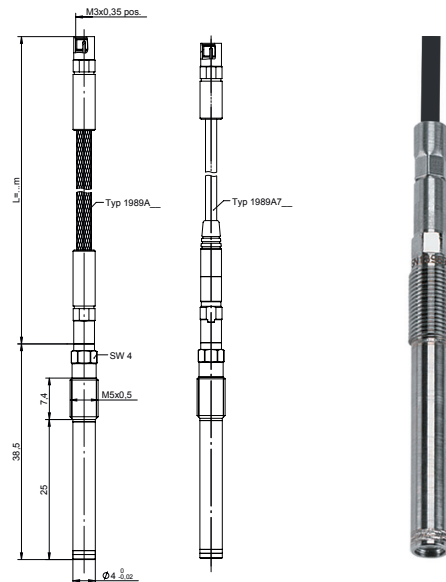

Technical data

Measuring range	bar	0 ... 250
Calibrated ranges	bar	0 ... 50, 0 ... 100, 0 ... 150, 0 ... 250
Overload	bar	300
Sensitivity	pC/bar	≈ -17
Natural frequency, nominal	kHz	≈ 160
Linearity in all ranges (at RT)	% FSO	≤ 0.3
Acceleration sensitivity	bar/g	≤ 0.0005
Operating temperature range	°C	$-20 \dots 350$
temperature, min./max.		$-50 \dots 400$
Sensitivity shift		
200 \pm 50 °C	%	$\leq \pm 0.5$
23 ... 350 °C	%	± 2
Short term drift (thermal shock)		
(at 1 500 1/min, IMEP = 9 bar)		
Δp (short-term drift)	bar	$\leq \pm 0.5$
Δ IMEP	%	≤ 2
Δp_{max}	%	≤ 1
Insulation resistance at 23 °C	Ω	$\geq 10^{13}$
Shock resistance	g	2 000
Tightening torque	N·m	1.2
Capacitance, without cable	pF	5
Weight with cable	g	30
Connector, ceramic insulator	–	M3x0.35

6058A_000-573e-03..19

Mounting in glow plug adapter

Sensor Type 6058A... is typically used in glow plug adapters (Fig. 3). For this purpose, Kistler offers the customized optimum adapters of the Type 6544Q... (see also data sheet 6542Q_000-570). These are provided with a hole bored according to requirements (Fig. 1) for the sensor mounting, and have been optimized with regard to signal quality and longevity. As a general rule, we would advise against the use of a self-manufactured glow plug adapter. On request, Kistler will provide an engine-specific adapter for your use.

General mounting

When mounting adapter, it is essential to comply with the tightening torque of 1,2 N·m. The sensor with therefore be mounted with cable connected and socket wrench Type 1300A14 and the torque wrench Type 1300A17.

A slotted mounting key must be used for sensors with PiezoSmart. The mounting bore must either be exactly $\varnothing 5,7$ mm (with step drill) or larger than $\varnothing 7,5$ mm. The mounting key Type 1300B14 is for $\varnothing 5,7$ mm. The mounting key Type 1300B14Q01 is for $\varnothing \geq 7,5$ mm.

For the tightening torque of the glow plug adapter into the cylinder head please refer to the specific data sheet.

Direct mounting

Sensor Type 6058A... can be mounted directly in the cylinder head (Fig. 2). When drilling the hole, bore specifications (Fig. 1) must be hold exactly.

The following Kistler tools:

Step drill	Type 1300A18
Tap	Type 1357A
Reaming tool	Type 1300A111

enable you to maintain the tolerances required. The hole must be drilled in one work holding fixture. Before mounting the sensors, in particular the sealing surface in the hole must be checked; use of the reaming tool Type 1300A111 is mandatory. You will find additional information on drilling the hole and mounting in the instruction manual. Your Kistler distributor will provide you with further information such as, for example, concerning the preferred location of the indicating bore in the combustion chamber.

Sleeve mounting

Where space allows or if the sensor must be mounted through the water jacket of the cylinder head, we recommend the use of a mounting sleeve. Mounting sleeves are manufactured to customer specifications. Fig. 4 shows a version with M6x0.5 thread. An additional advantage of mounting sleeves is that the actual sensor bore in the sleeve can be very precisely machined. On request, Kistler will provide drawings for your particular mounting situation.

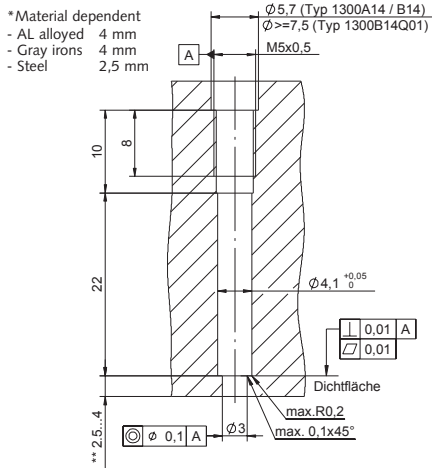

Fig. 1: Dimensions of mounting bore

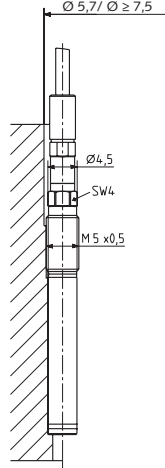

Fig. 2: Direct mounting

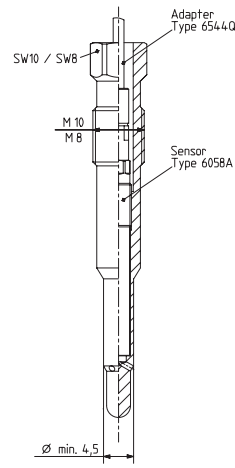

Fig. 3: Mounting in glow plug adapter

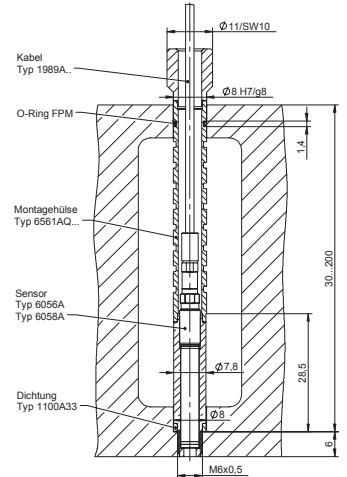

Fig. 4: Mounting in mounting sleeve

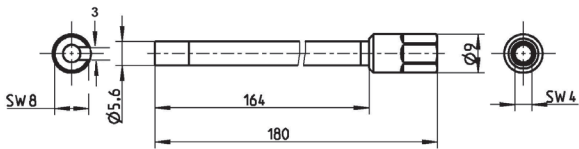

Fig. 5: Mounting key Type 1300A14

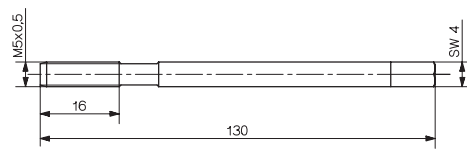

Fig. 6: Special tap Type 1357A

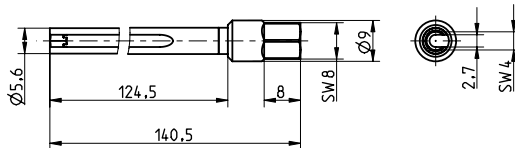

Fig. 7: Mounting key $\varnothing 5,6$ mm, slotted, Type 1300B14

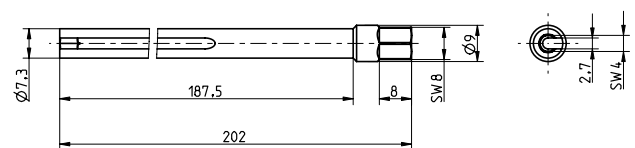

Fig. 8: Mounting key $\varnothing 7,3$ mm, slotted, Type 1300B14Q01

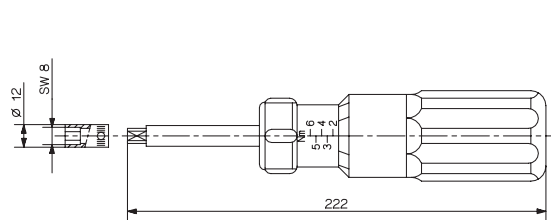

Fig. 9: Torque wrench Type 1300A17

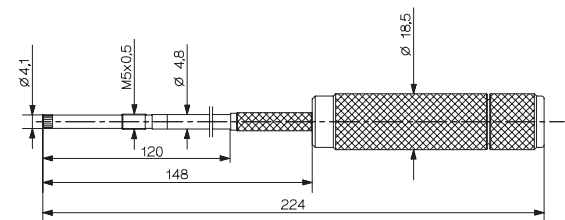

Fig. 10: Reaming tool Type 1300A111

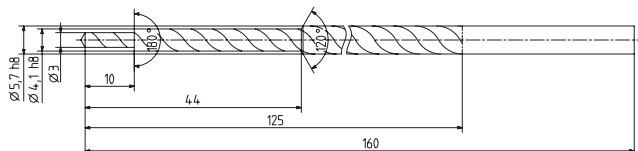

Fig. 11: Step drill Type 1300A18

6058A_000-573e-03.19

Scope of delivery

- Pressure sensor
- Connecting cable acc. to ordering key
- Calibration certificate
- Adapter M3x0.35 neg. – BNC pos. (not for PiezoSmart)

Type/Art. No.

1706

Ordering key

Without PiezoSmart	–
With PiezoSmart	5

Type 6058A

Optional accessories

- Adapter Triax – BNC pos. 1704A4
- PiezoSmart extension cables
 - L = 1 m 1987B1
 - L = 2 m 1987B2
 - L = 10 m 1987B10
- Replacement connecting cables, PFA steel braiding
 - L = 1 m 1989A311
 - L = 2 m 1989A321
 - L = 3 m 1989A331
 - incl. PiezoSmart, L = 1 m* 1985A8S311
 - incl. PiezoSmart, L = 2 m* 1985A8S321
 - incl. PiezoSmart, L = 3 m* 1985A8S331
- Replacement connecting cables, FPM oil-tight
 - L = 1 m 1989A711
 - L = 2 m 1989A721
 - L = 3 m 1989A731
 - incl. PiezoSmart, L = 1 m* 1985A8S711
 - incl. PiezoSmart, L = 2 m* 1985A8S721
 - incl. PiezoSmart, L = 3 m* 1985A8S731
- Mounting key standard
Ø5.6 mm, not slotted (L = 180 mm) 1300A14
- Mounting key for PiezoSmart
 - Ø5.6 mm, slotted (L = 140.5 mm) 1300B14
 - Ø7.3 mm, slotted (L = 202 mm) 1300B14Q01
 - Ø7.3 mm, slotted (L = 242 mm) 1300B14Q03
- Torque wrench 1 ... 6 N·m 1300A17
- Step drill 1300A18
- Tap M5x0.5 1357A
- Reamer 1300A111
- Mounting sleeve incl. O-ring¹⁾ 6561AQ...
- O-ring for mounting sleeve 65007541
- Adapter for pressure generator
Type 6904 6591
- Temperature dummy 6058AT
- Dummy sensor 6405A1
- Extraction tool for dummy sensor
Type 6405 1349

Cable type

Without cable	–
PFA with steel braiding	3
Fluoropolymer, oil-proof	7

Cable length

Without cable	–
1 m	1
2 m	2
3 m	3

For PiezoSmart specifications please refer to the PiezoSmart brochure.

Ordering examples

- Version with 1 m FPM oil-proof cable
- Version with PiezoSmart and 2 m FPM oil-proof cable

Type
6058A-7-1
6058AS7-2

6058A_000-573e-03.19

* with factory calibration data, state SN with order
¹⁾ customer specific