

K-Shear Accelerometer

Type 8792A...

Through hole mounting, voltage triaxial accelerometer

The triaxial accelerometer Type 8792A... measures vibration in three mutually perpendicular axis. They are available in four measuring ranges from $\pm 25 \dots 500$ g and feature a housing through hole allowing a single bolt to attachment to the test structured.

- Low impedance, voltage mode output
- Quartz shear sensing elements
- High immunity to thermal transients
- Ultra-low base strain sensitivity
- Wide frequency range
- Ground isolated
- Low profile design
- Conforming to CE

Description

The quartz shear triaxial accelerometers Type 8792A... are rugged, low impedance voltage mode sensors. They are available in four ranges from 25 ... 500 g with sensitivities from 10 ... 200 mV/g. This triaxial design allows simultaneous shock and vibration measurements in three mutually perpendicular axes: X, Y and Z.

Kistler's K-Shear design provides a wide operating frequency range along with extremely low sensitivity to thermal transients, base strain and transverse acceleration. Quartz sensing crystals ensure the long-term stability not achievable with other sensing materials. Three Piezotron microelectronic circuits convert the charge signal from each quartz element into a useable high level voltage signal at a low impedance output allowing the use of low-cost cables. An advantage of the low impedance output is the ability to drive long cable lengths with low-noise susceptibility.

The welded, stainless steel construction is hermetically seals the accelerometer when subjected to adverse environments and the ground isolated base design eliminates ground loops.

Application

The accelerometers measure simultaneously the three components of the acting acceleration enabling any model to be used for general purpose vibration measurement in a laboratory or industrial environment. The single center mounting hole allows for convenient attachment and alignment of the X and Y axis.

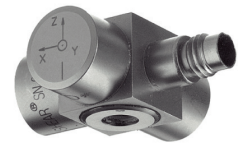

Type	A	B
8792A...	24,3	36,1
8792A500	21,1	29,2

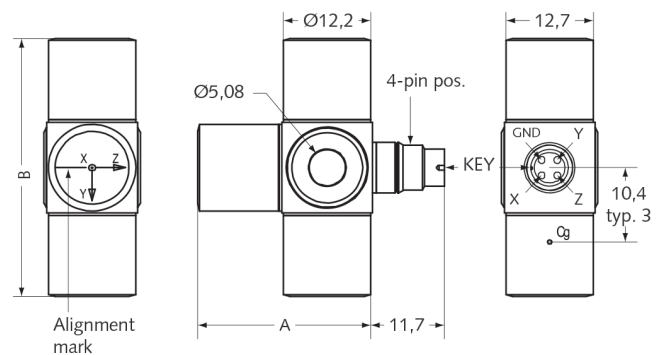

Accessing TEDS data

Accelerometers with a "T" suffix are variants of the standard version incorporating the "Smart Sensor" design. Viewing an accelerometer's data sheet requires an Interface/Coupler such as Kistler's Type 5165A... or 5000M04 with TEDS Editor software. The Interface provides negative current excitation (reverse polarity) altering the operating mode of the PiezoSmart sensor allowing the program editor software to read or add information contained in the memory chip.

Mounting

Reliable and accurate measurements require that the mounting surface be clean and flat. The sensor can be attached to the structure with a single 10-32x³/₄" socket head cap screw. The instruction manual for Type 8792A... (87xx_002-080) provides detailed information regarding mounting surface preparation.

8792A_000-260e-04_20

Technical data

Specification	Unit	Type 8792A25	Type 8792A50	Type 8792A100	Typ 8792A500
Acceleration range	g	±25	±50	±100	±500
Acceleration limit	gpk	±50	±100	±200	±1 000
Threshold, nom.	grms	0,002	0,004	0,006	0,01
Sensitivity (±5 %)	mV/g	200	100	50	10
Resonant frequency mounted, nom.	kHz	54	54	54	54
Frequency response, (±5 %)	Hz	1 ... 5 000	0,5 ... 5 000	0,5 ... 5 000	1 ... 5 000
Amplitude non-linearity	%FSO	±1	±1	±1	±1
Time constant, nom.	s	1	2	1,5	1
Transverse sensitivity, nom. (max.)	%	1,5 (3)	1,5 (3)	1,5 (3)	1,5 (3)
Long term stability	%	±1	±1	±1	±1

Environmental

Base strain sensitivity @ 250 µε	g/µε	0,005	0,005	0,005	0,005
Shock limit (1 ms pulse)	gpk	2 000	2 000	2 000	5 000
Temperature coefficient of sensitivity	%/°C	-0,06	-0,06	-0,06	-0,06
Operating temperature range	°C	-55 ... 100	-55 ... 100	-55 ... 100	-55 ... 120
Storage temperature range	°C	-75 ... 120	-75 ... 120	-75 ... 120	-75 ... 120

Output

Bias, nom.	VDC	11	11	11	11
Impedance	Ω	<100	<100	<100	<100
Voltage full scale	V	±5	±5	±5	±5
Current	mA	2	2	2	2

Source

Voltage	VDC	20 ... 30	20 ... 30	20 ... 30	20 ... 30
Constant current	mA	2 ... 20	2 ... 20	2 ... 20	2 ... 20
Impedance, min.	kΩ	100	100	100	100

Construction

Sensing element	Type	quartz-shear	quartz-shear	quartz-shear	quartz-shear
Case/base	material	St. Stl.	St. Stl.	St. Stl.	St. Stl.
Degree of protection case/connector	Type	IP68	IP68	IP68	IP68
Connector	Type	4-pin pos.	4-pin pos.	4-pin pos.	4-pin pos.
Ground isolated		yes	yes	yes	yes
Mass	grams	29	29	29	27
Mounting (ø5,1 hole)	Type	cap screw	cap screw	cap screw	cap screw

1 g = 9,80665 m/s², 1 Inch = 25,4 mm, 1 gram = 0,03527 oz, 1 lbf-in = 0,113 N-m

Included accessories

- Socket cap head screw, 10-32x3/4" long
- Socket cap head screw, M5x20 mm long

Optional accessories

- Extension cable, 4-pin pos. to 4-pin neg.
- Cable, 1/4-28, 4 pin neg. to 3x BNC pos.
- Cable, BNC pos. to BNC pos.

Art. No.

431-0475-003
431-0494-001

Type

1578A...
1756C...
1511

Ordering key

Type 8792A

Measuring range

±25 g	25
±50 g	50
±100 g	100
±500 g	500

TEDS templates

Standard	-
Default, IEEE 1451.4 V0.9	T
Template 0 (UTID 1)	
IEEE 1451.4 V0.9	T01
Template 24 (UTID 116225)	
LMS template 117, free format ID	T02
LMS template 118, automotive format (field 14 geometry = 0)	T03
LMS template 118, aerospace format (field 14 geometry = 1)	T04
P1451.4 V1.0 template 25 – ransfer function disabled	T05
P1451.4 V1.0 template 25 – transfer function enabled	T06





Measure	Connect	Amplify	Output	Analyze
 Type 8792A... Low impedance	 Type 1756C... 1/4-28, 4 pin neg. 3xBNC pos.	 Type 51... Power supply / signal conditioner	 Type 1511 BNC pos. BNC pos.	 not supplied

Fig. 1: Measuring chain

8792A_000-260e-04_20