

## RoaDyn S635

Type 9267A1

### Wheel force transducer for heavy cars and high performance vehicles

For measuring three forces and three moments on a rotating wheel; a major constituent in modern vehicle development.

- Modular design with replaceable measuring cells and components
- CAD/FEM supported design: optimization of local stresses
- High strength/low WFT weight in combination with high rigidity
- Excellent signal quality due to digitization already in the wheel electronics
- Automatic identification of components by ID chip
- Calibration of the individual load cells as well as of the WFT assembly
- Tested structural fatigue strength e.g. to SAEJ328

#### Description

The RoaDyn S635 wheel force transducer (WFT) has a modular, versatile design for mounting on hubs and rim geometries. Five 3-component strain gage load cells are connected by adapter parts to a rim and to the vehicle hub. The signals are amplified immediately in the load cells and fed via short cables to the wheel electronics. Here they are filtered, digitized and coded. The data stream is transmitted via a rotor/stator pair to the wheel inner side, transformed in the on-board electronic unit and output to a data acquisition device.

This WFT is designed for exceptionally high forces and moments associated with heavy cars and high-performance vehicles. Because of often large wheel offsets, the load on the wheels is particularly high, specially with regard to moments. The anticipated stresses are determined using the FE method, and the design optimized with regard to strength, safety and weight. Dynamic cornering fatigue investigations make it possible to validate the life of the WFT structure.



Additional signals on the rotating wheel, such as tire pressure, temperature, etc. can be directly connected to the wheel electronics and transmitted along with the wheel signals. Kistler offers optional amplifier modules for this purpose. The wheel electronics is available in versions with 20 ... 24 channels.

Note: see data sheets 5240A\_000-561, 5248A\_000-562 and 9817-003-233 for the transmission units and the on-board electronics.

### Application

- Measuring operating loads during typical vehicle driving maneuvers
- Input data for the design of new components
- Verification of design loads
- Measuring test stand control data for road simulators
- (Permanent) application as multi-axle force measuring unit in road simulators
- Development of active chassis control systems such as ABS, ESP, etc.
- Investigations of vehicle behavior in specific or critical driving situations
- Input data for fatigue calculations and numeric simulations
- Development of computer models

Usually 4 or 2 WFTs are used. Occasionally measurements with a single WFT are also employed for component or tire development. The various test vehicles require adaptation to new wheel/hub geo-metries. The modular design of the WFTs and proficient support by Kistler application centers has proved successful for this purpose.

At the same time as the WFTs, systems for wheel motion measurement or optical sensors (such as for measuring tire and body slip angle, speed or accelerations) can also be used. Adaptations for applying individual sensors to the measuring wheels are available in the Kistler product range.

The WFT system described above can also be used on a vehicle test stand. Its daily exclusive use on a test stand requires, among other things, special technical characteristics, which have led to the development of a special system. Further information is contained in the data sheet 9248A2\_000-696.

### Technical Data

Measuring range <sup>1)</sup>	$F_x$ <sup>2)</sup>	kN	-35 ... 35
	$F_y$	kN	-20 ... 20
	$F_z$ <sup>2)</sup>	kN	-35 ... 35
	$M_x$	kN·m	-5 ... 5
	$M_y$	kN·m	-5 ... 5
	$M_z$	kN·m	-5 ... 5
Rotary angle accuracy		°	≈0,1
Weight WFT <sup>3)</sup>	m	kg	≈16,5

### Maximum Loads

Degree of protection			IP64
Operating temperature range aluminum components		°C	<160
Max. speed		km/h	>300
Max. impact accelerations	x	g	50
	y	g	50
	z	g	50

### Accuracy

Linearity		% FS	≤0,5
	Typical <sup>4)</sup>	% FS	≤0,15
Hysteresis		% FS	≤0,5
	Typical <sup>4)</sup>	% FS	≤0,10
Crosstalk forces		% FS	≤0,5
	Typical <sup>4)</sup>	% FS	≤0,10

Permitted alternating stress (rotating bending fatigue test)

The requirements according to SAE J328 are exceeded.  
500 000 LC at 6.0 kN·m

<sup>1)</sup> It is assumed that these extreme values do not occur simultaneously. The moments refer to the wheel center.

<sup>2)</sup> In combination with outer part 9731A53Q1 and load cells 9190A8D7: 40 kN

<sup>3)</sup> With 6x16" aluminum rim, rotor, wheel electronics, hub adapter, but without ET adapter, wheel bolts and tires

<sup>4)</sup> The typical accuracy corresponds to the median of the results of end-of-line and e-calibrations

Sensor setup

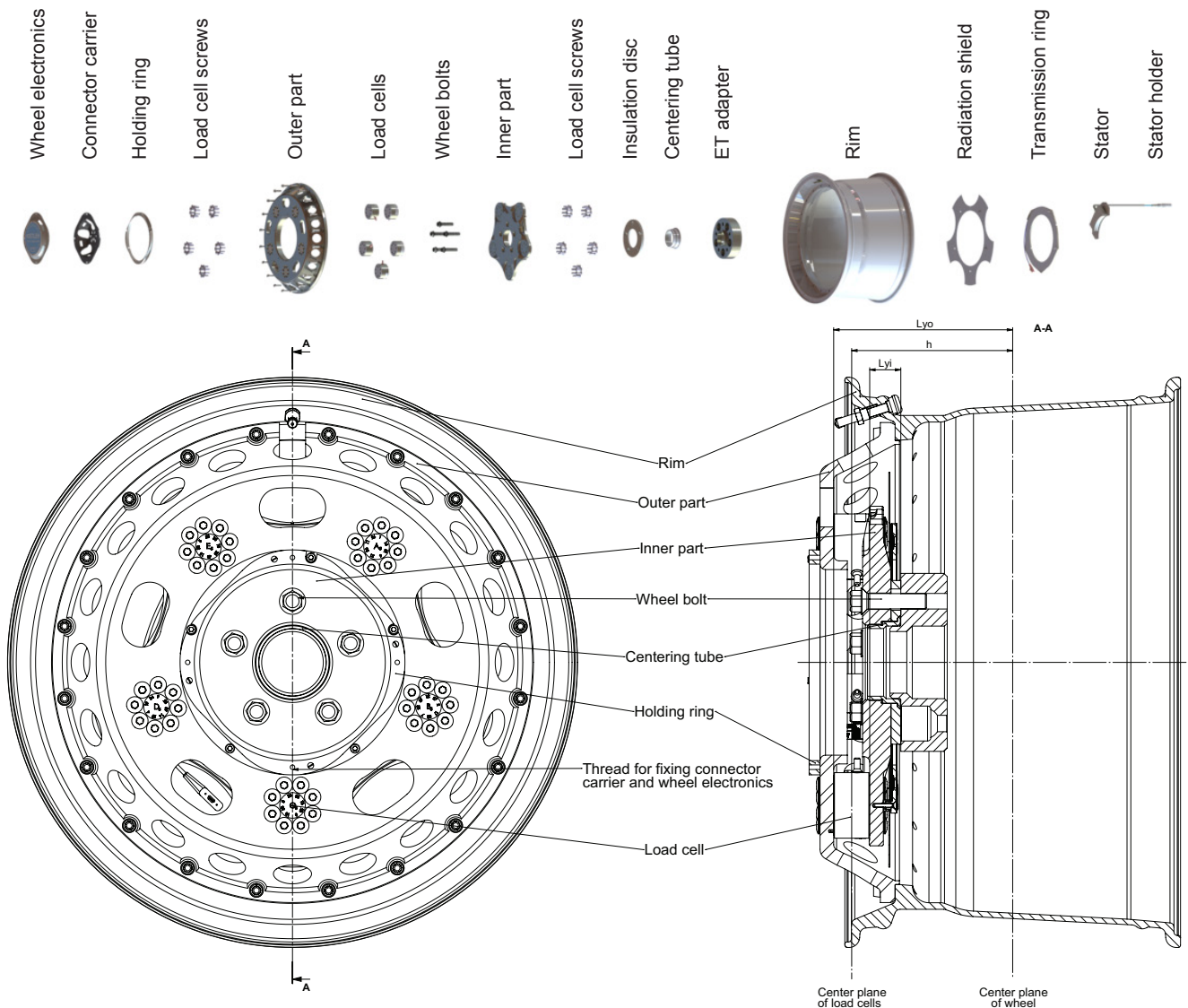

Fig. 1: RoaDyn S635 structure/components with in-board transmission

9267A1\_000-559e-07\_19

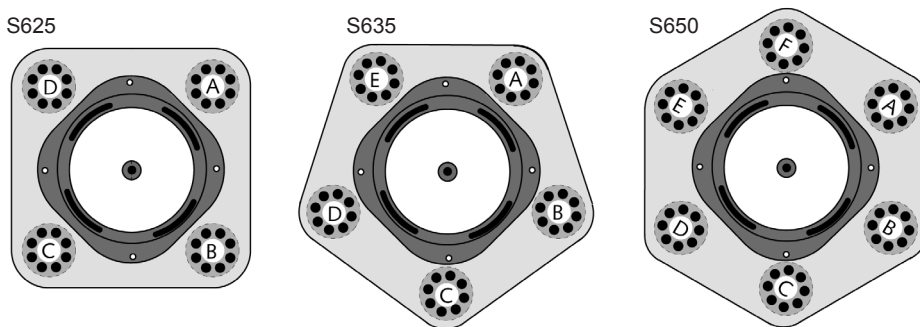











Fig. 2: Expandability of the RoaDyn S6 WFT system. The wheel force transducer can be adapted for higher load limits or a test stand by expanding the wheel force system with exchangeable measuring cells and mechanical adaptations

**RoaDyn S635 Measuring Chain Configurations**

Wheel Force Transducer	Data Transmission	Connection Cable	On-board Electronics	
Type 9267A1 with wheel electronics Type 5241A2 and rim Type Z39913A...	Type 5240A..., 5242A... In-board transmission unit consisting of rotor and stator	Type 30430A... Connection between stator and on-board electronics	Type 9817A.. KiRoad Performance	Type 18025602 KiCenter
				

Wheel Force Transducer	Data Transmission	Connection Cable	On-board Electronics	
Type 9267A1 with wheel electronics Type 5241A2 and rim Type Z39913A...	Type 5240A... Out-board transmission unit	Type 30430A... Connection between stator and on-board electronics	Type 9817A.. KiRoad Performance	Type 18025602 KiCenter
				

**Mounting**

Kistler offers weight and strength optimized mechanical structural parts to adapt to the customer's vehicles.

**Mounting the Stator with In-Board Transmission**

With in-board transmission, a suitable mounting device is mounted on the wheel carrier or suspension strut for the stator. The position of the stator and the location of the support is then established with a gauge.

With the stator installed, mounting a WFT is comparable with that of a production wheel. The stator can also remain mounted on the vehicle if this is running on production wheels. When the WFTs are remounted, measurements can be made again immediately.

With out-board transmission, a support arm must additionally be included in the vehicle setup, to which the cable to the on-board electronics is fixed.

9267A1\_000-559e-07\_19

<b>System components</b>	<b>Type/art. no.</b>	<b>Optional accessories</b>	<b>Type/art. no.</b>
<ul style="list-style-type: none"> <li>• 3-component strain gage load cells, completely encapsulated, 5 per wheel alternatively:</li> </ul>	9190A4...	<ul style="list-style-type: none"> <li>• Precision spirit level, 1 per measuring system</li> </ul>	Z30208
<ul style="list-style-type: none"> <li>• 3-component strain gage load cells, completely encapsulated, 5 per wheel</li> </ul>	9190A8...	<ul style="list-style-type: none"> <li>• Adjuster gage for stator mounting, 1 per system</li> </ul>	Z39911Q
<ul style="list-style-type: none"> <li>• Internal part, 1 per wheel</li> </ul>	9729A5	<ul style="list-style-type: none"> <li>• Tire mounting tool, 1 per measuring system</li> </ul>	Z30210
<ul style="list-style-type: none"> <li>• Connector holder for wheel electronics, 1 per wheel</li> </ul>	Z39904	<ul style="list-style-type: none"> <li>• Key for centering sleeve Type Z39901, 1 per measuring system</li> </ul>	Z30205
<ul style="list-style-type: none"> <li>• Outer part, 1 per WFT</li> </ul>	9731A5...	<ul style="list-style-type: none"> <li>• 3-channel strain gage bridge amplifier (SGAM)</li> </ul>	2237A1
<ul style="list-style-type: none"> <li>• Rim, 1 per WFT</li> </ul>	Z39913A...	<ul style="list-style-type: none"> <li>• 3-channel thermocouple amplifier (TCAM)</li> </ul>	2237A2
<ul style="list-style-type: none"> <li>• Ring antenna (rotor), 1 per WFT</li> </ul>	5242A5		
<ul style="list-style-type: none"> <li>• Wheel electronics, 1 per WFT</li> </ul>	5241A2...		
<ul style="list-style-type: none"> <li>• Hub adapter package, containing heat-insulation disks, centering sleeve and wheel bolts</li> </ul>	9711A3	<p><b>Ordering code</b></p> <ul style="list-style-type: none"> <li>• RoaDyn S635</li> </ul>	<b>Type 9267A1</b>
<ul style="list-style-type: none"> <li>• Wheel offset adapter, 1 per wheel</li> </ul>	9713A...	<ul style="list-style-type: none"> <li>Wheel force transducer (WFT) for heavy cars and high-performance vehicles</li> </ul>	
<ul style="list-style-type: none"> <li>• KiRoad Performance</li> </ul>	9817A...		