

# Acoustic Emission Sensor

## for High Temperature & Hazardous Areas

Piezotron® Acoustic Emission Sensor with an integral impedance converter for measuring acoustic emissions (AE) above 50 kHz in bearing based machine structures, high pressure vessels, compressors or valves. With its small size, it easily mounts near the source of emissions to optimally capture the signal. A M6 or ¼–28" bolt is all that is needed. Available in both intrinsically or non-intrinsically safe versions, this very rugged sensor has a welded housing for IP65 protection with high temperature operation up to 165° C [330 °F].

- Standard, ATEX/CSA Zone 0 or ATEX/CSA Zone 2 versions available
- High sensitivity and wide frequency range
- Inherent high-pass characteristic
- Insensitive to electric and magnetic noise fields
- Robust, for industrial use (IP65)
- High operating temperature range: –55 ... 165° C [–65 ... 330 °F]
- Ground isolated: prevents ground loops
- Conforming to CE

### Description

The Piezotron® AE-Sensor consists of the sensor housing, the piezoelectric sensing element, and the built-in impedance converter. The sensing element, made of piezoelectric ceramic, is mounted on a thin steel diaphragm. Its construction determines the sensitivity and frequency response of the sensor. The coupling surface of the diaphragm welded into the housing is slightly protruded to measure the AE signals. Thus, a precisely defined coupling force results when mounting. This assures a constant and reproducible coupling for the AE transmission. The sensing element is acoustically isolated from the housing by design and therefore well protected against external noise. Kistler AE sensors feature a very high sensitivity for surface (Rayleigh) and longitudinal waves over a broad frequency range and are designed to withstand high energy waves. Type 8152C0... covers 50 ... 400 kHz and Type 8152C1... covers 100 ... 900 kHz. Type 8152Cxy00... will exist only in a PFA cable where Type 8152Cxyyyy... will provide a protective conduit with a length yy. This conduit can be terminated with ¼ NPT Male or M13x1-6g to adapt to your system. Finally, Type 8152C...1 is provided with a Zone 0 Certification in Europe & North America where Type 8152C...2 is provided with a Zone 2 Certification.

A non-ATEX version, Type 8152C...0, is also available for lower cost applications where a non-intrinsically safe solution is acceptable. A miniature impedance converter is built into the Piezotron®

### Type 8152C...

Type 8152Cxyy00xx with PFA jacketed cable

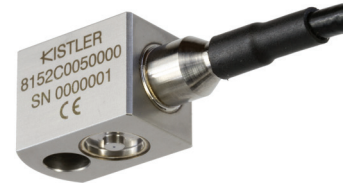

Type 8152Cxyyyyxx with braided cable

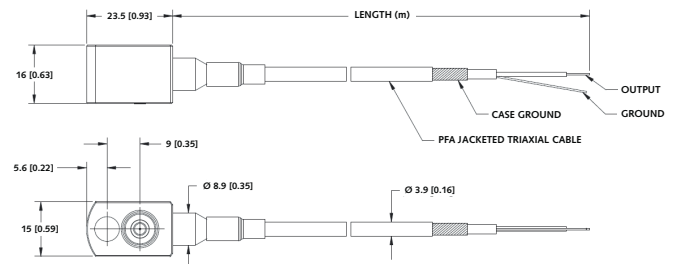

Outline drawing for Type 8152Cxyy0000x with yy m of PFA jacketed cable and no armor conduit (units: mm [in])

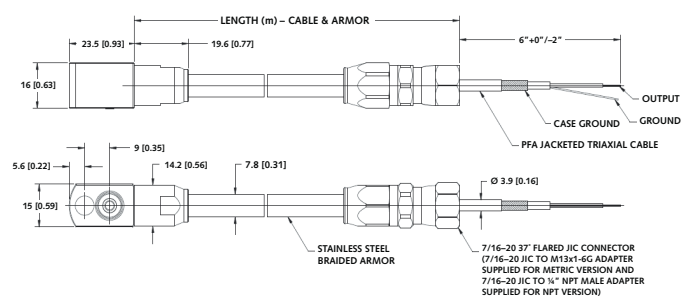

Outline drawing for Type 8152Cxyyyyxx with yy m of PFA jacketed cable and yy m of armor conduit (units: mm [in])

AE-Sensor, giving a low impedance voltage output signal.

The AE Piezotron® Coupler is used to supply power to the sensor and for signal processing. Different coupler options are offered depending on the ATEX or non-ATEX requirement (please refer to the Measurement Configuration and Ordering Key sections of this document to guide you). Special highly insulating and low noise connecting cables are not required.

8152C\_003-120e-01.16

## Technical Data

Type	Unit	8152C0...0	8152C1...0	8152C0...1	8152C1...1	8152C0...2	8152C1...2
<b>Dynamic</b>							
Frequency range $\pm 10$ dB	kHz	50 ... 400	100 ... 900	50 ... 400	100 ... 900	50 ... 400	100 ... 900
Sensitivity	dBref 1V/ (m/s)	57	48	57	48	57	48
<b>Environmental</b>							
Overload shock (0.5 ms pulse)	gpk	2,000					
Operating temperature range	°C [°F]	-55 ... 165 [-65 ... +330]					
<b>Electrical - Output</b>							
Bias, nom.	VDC	2.2					
Impedance	$\Omega$	<10					
Voltage full-scale	V	$\pm 2$					
Current	mA	2 ... 4					
<b>Source</b>							
Voltage (Coupler)	VDC	5 ... 36					
Constant current	mA	3 ... 6					
<b>Construction</b>							
Sensing element	type	ceramic					
Housing/base	material	stainless steel					
Protection-housing/connector		IP65 (EN 60529 @ NEMA 4X)					
Ground isolation	M $\Omega$	>1	>1 M $\Omega$ , Isolation Test Voltage ( $\geq 1$ min.; 5 mA) $\geq 500$ VAC				
PFA/Armored cable lengths	m	standard length of 3 m, 5 m, 10 m, 15 m, or 20 m					
PFA cable bend radius	mm	25					
Armor conduit bend radius	mm	38					
Weight (head without cable)	gr	29					
Mounting torque	N·m	9 $\pm$ 1					
<b>Certification &amp; Standards</b>							
CE - EMC		EMC compliant with EN 61236-1:2006					
Hazardous Areas		Non-Intrinsically Safe	ATEX Zone 0 II 1GD, Ex ia IIC T85C/T100C/ T135C/T185C Da, Ex ia IIC T6/T5/T4/T3 Ga (-55 °C $\leq$ Ta $\leq$ +60 °C/+75 °C/ +110 °C/+165 °C) per EN 60079-0:2012, EN 60079-11:2012		ATEX Zone 2 II 3G, Ex na IIC T6/T5/T4/T3 Gc (-55 °C $\leq$ Ta $\leq$ +60 °C/+75 °C/ +110 °C/+165 °C) per EN 60079-0:2012, EN 60079-15:2010		

1 g = 9.80665 m/s<sup>2</sup>, 1 Inch = 25.4 mm, 1 Gram = 0.03527 oz, 1 lbf-in = 0.113 N·m

**Measuring Configurations – for Type 8852A System, Type 8152C Sensor, Type 5125C Coupler and Type 5252A Wide Band IS Barriers**

**Configuration 1: Standard AE Measuring Chain**

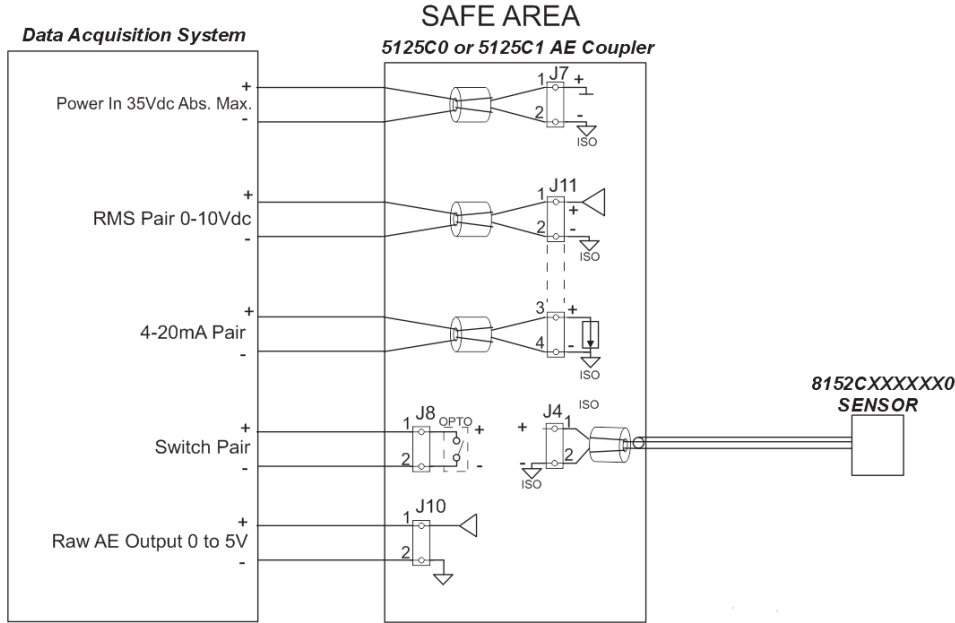

**Configuration 2: Type 8152C Sensor in Hazardous Area Zone 0, Type 5125C Coupler in a Safe Area – Real-time AE output and RMS output available.**

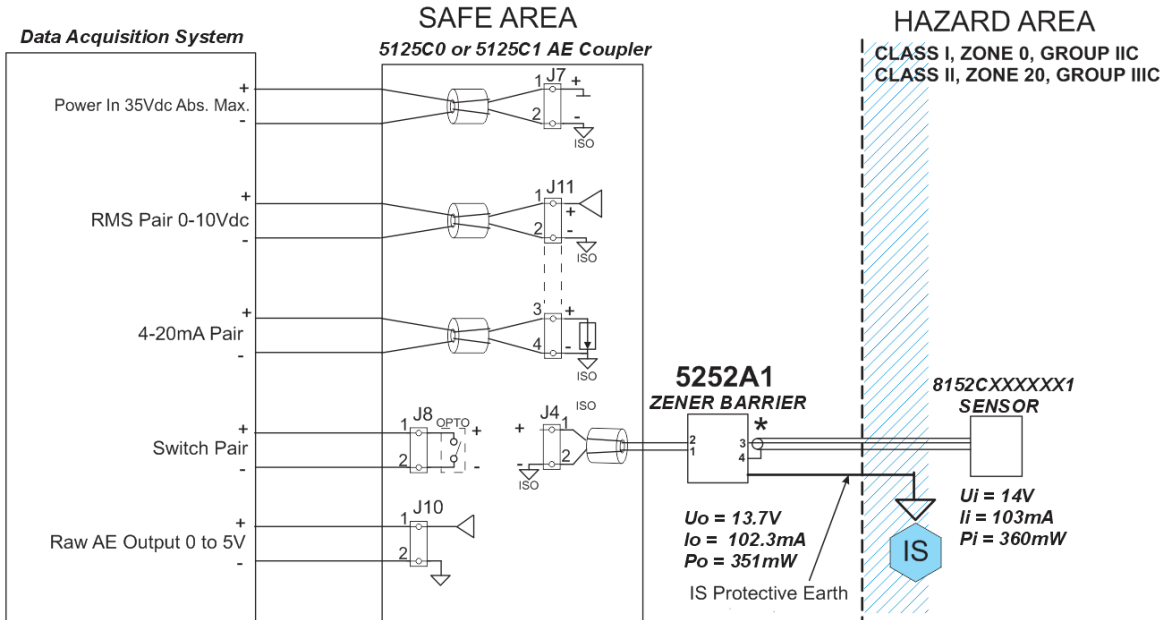

8152C\_003-120e-01.16

\*Special Condition for Safe Use: The free ends of the cable must be terminated such that they are afforded a degree of protection of not less than IP20.

**WARNING:** Only ATEX Sensors Type 8152C... with serial number SN 4944583 and higher are compatible with the Type 5252A1 Wideband Zener Barrier.

**Configuration 3: Type 8152C Sensor in Hazardous Area Zone 0, Type 5125C Sensor in Hazardous Area Zone 0 – only RMS output available.**

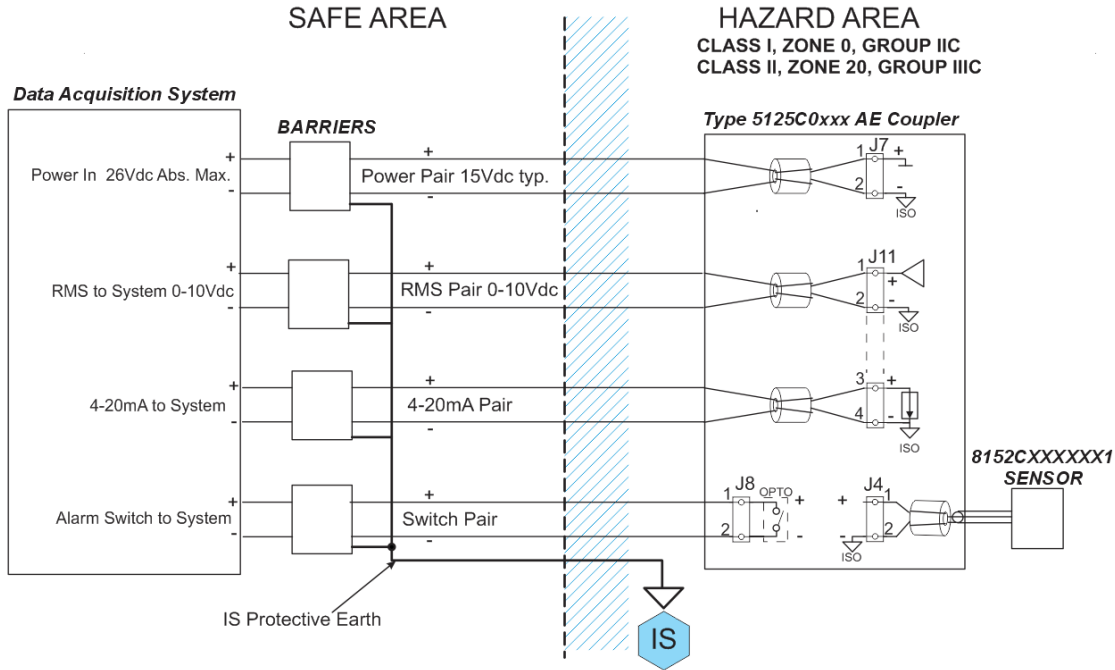

**Configuration 4: Type 8152C Sensor in Hazardous Area Zone 2, Type 5125C Coupler in a Safe Area – Real-time AE output and RMS output available.**

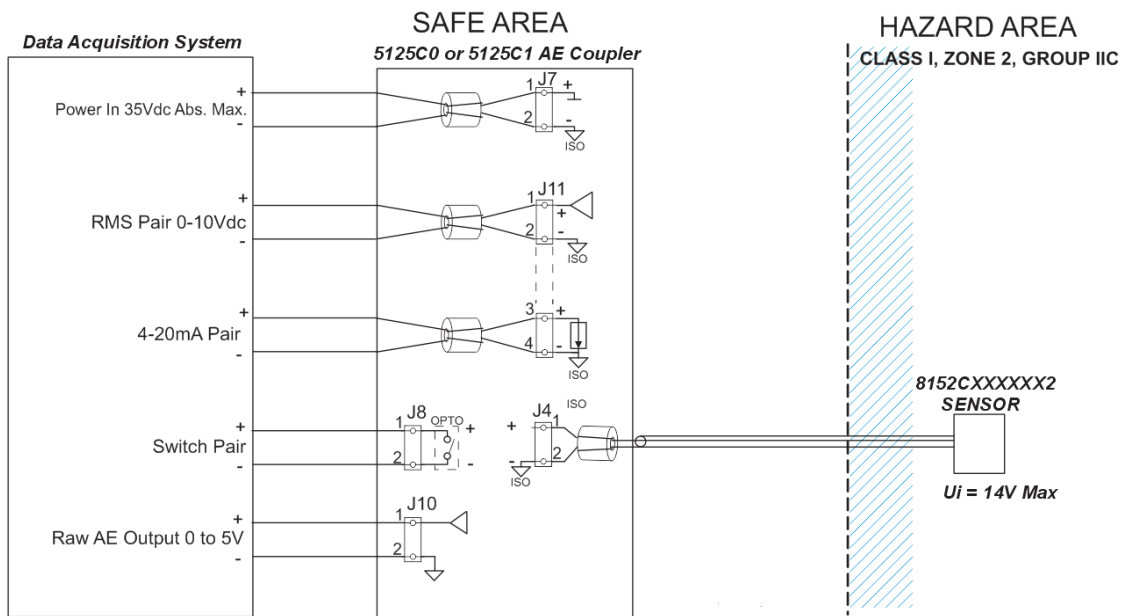

8152C\_003-120e-01.16

**Configuration 5: Type 8152C Sensor in Hazardous Area Zone 2, Type 5125C Sensor in a Hazardous Area Zone 2 – only RMS output available.**

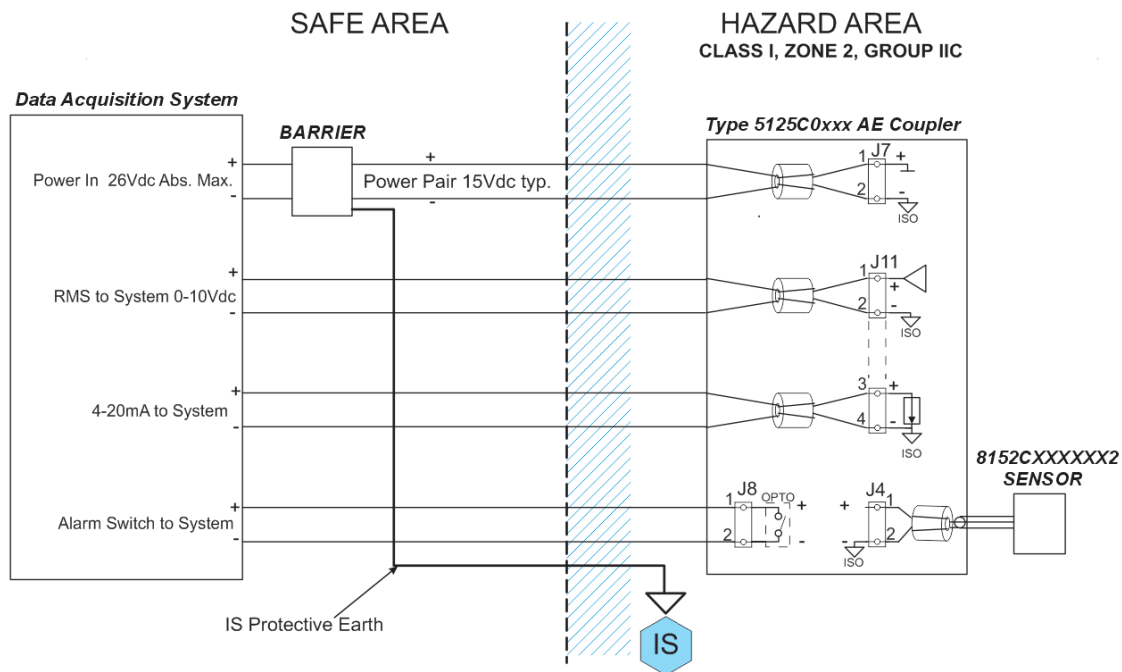

8152C\_003-120e-01.16

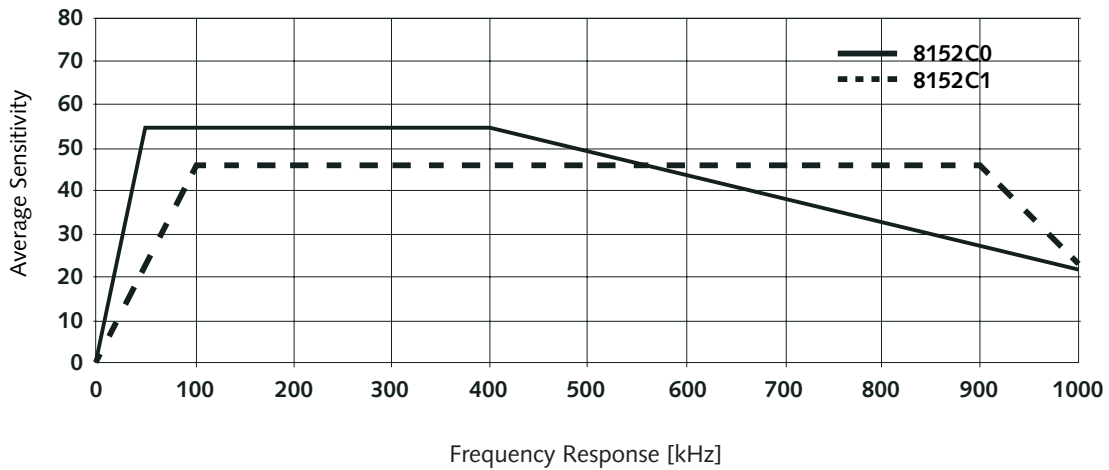

Fig. 1: Types 8152C0 and 8152C1 frequency response spectrum

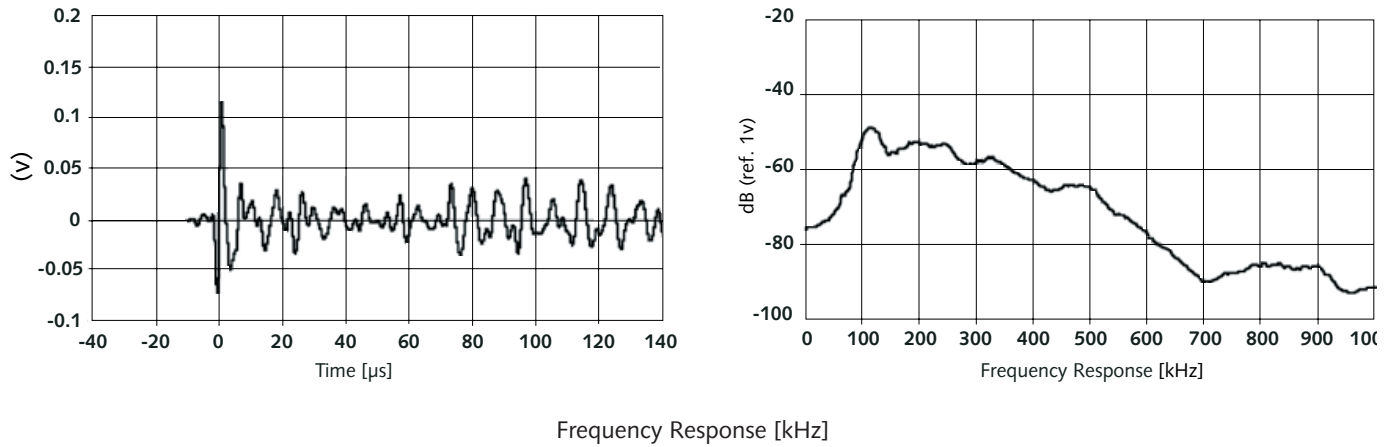

Fig. 2: AE-Sensor frequency response example in both time and frequency domain using AE real-time output from coupler

8152C\_003-120e-01.16

### Application

The AE measuring chain is dedicated to industrial customers from Automotive, Petrochemical, Power Generation and Aerospace industries who need to monitor bearing based machinery, pressure vessels or flow turbulence with high frequency acoustic signatures. AE measuring can be used where vibration sensors cannot due to the high energy provided by the emitted elastic waves. It also allows for separation of a high vibration environment from fatigue and failure signals of interest. The measuring chain, for example, can be used for non-destructive testing or permanent online monitoring of continuous processes for conditional and preventive maintenance. The high temperature operation, up to 165 °C [330 °F], and ATEX certifications option allows usage in hazardous environments, such as processing industries application where explosive gas and dust is always present.

### Mounting

The AE Sensor is simply mounted with a M6, 1/4" machine screw or a Type 8443B magnetic clamp onto the surface of the structure. A minimum tightening torque is sufficient for a reproducible and constant coupling. The smoother the mounting surface, the better the results. The use of a highly viscous grease (e.g. silicone grease) between coupling surfaces is recommended.

#### Type 8443B Magnetic Clamp

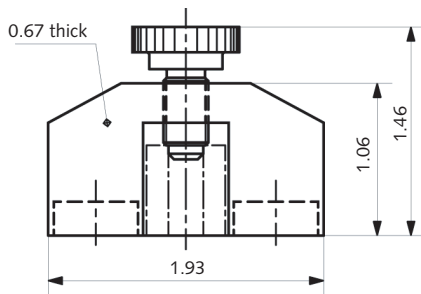

#### Mounting AE-Sensor

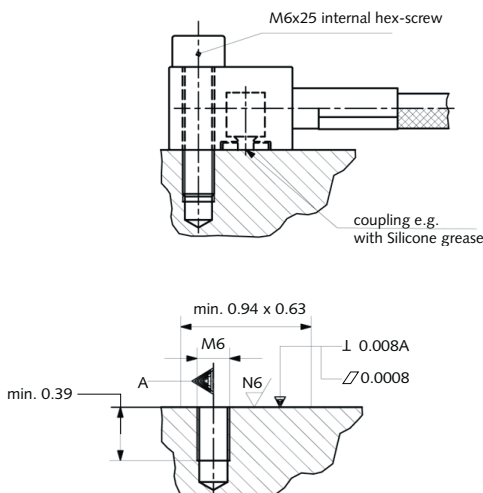

### Included Accessories

- Mounting screw, 1/4–28 x 1"
- Mounting screw, M6x25 mm

### Type

- 431-0500-001
- 431-0497-001

### Optional Accessories

- Magnetic clamp **Type** 8443B
- Non-Intrinsically Safe Piezotron® AE Coupler **Type** 5125C0, 5125C1
- Intrinsically Safe Piezotron® AE Coupler (ATEX/CSA Zone 0) **Type** 5125C0x0x
- Intrinsically Safe Piezotron® AE Coupler (ATEX/CSA Zone 2) **Type** 5125C0x2x
- Intrinsically Safe Wideband Zener Barrier **Type** 5252A1

Please reference Type 5125C or 5252A1 data sheets for more information.

### Ordering Key

		Type 8152C	<input type="checkbox"/>	<input type="checkbox"/>	<input type="checkbox"/>	<input type="checkbox"/>	<input type="checkbox"/>
<b>Sensitivity</b>							
57 dBref 1 V(m/s)	0						
48 dBref 1 V(m/s)	1						
<b>PFA Cable Length in m</b>							
yy = standard length 03, 05, 10, 15, 20 m	yy						
<b>Armor Conduit</b>							
No Conduit	00						
yy = standard length 03, 05, 10, 15, 20 m (similar to PFA cable)	yy						
<b>Cable Termination</b>							
Pigtail or 7/16–20 conduit adaptor (for connection to Type 5125C...)	0						
1/4 NPT male conduit adaptor & pigtail cable termination (for connection to customer system)	1						
M13x1–6 g conduit adaptor & pigtail cable termination (for connection to customer system)	2						
<b>Intrinsically Safe Certification</b>							
None	0						
Zone 0 Certification in Europe & North America	1						
Zone 2 Certification in Europe & North America	2						

8152C\_003-120e-01.16