

K-Beam Accelerometer

Type 8316A...

Capacitive MEMS, Single-Axis Accelerometer

Type 8316A... is a high-sensitivity, low-noise, single-axis accelerometer family which measures acceleration and low frequency vibration in the primary sensing axis. The accelerometer features include:

- Measuring ranges: ± 2 g, ± 10 g, ± 30 g, ± 50 g, ± 100 g, ± 200 g
- Frequency response: 0 ... 2,000 Hz (5 %) (except ± 2 g)
- Output Options: 0 ± 4 V or 2.5 ± 2 V single ended, 0 ± 4 V or 0 ± 8 V differential
- Operating temperature: -55 ... 125 °C [-65 ... 260 °F]
- Low noise
- Excellent thermal stability
- 25.4 mm x 21.59 mm [1.00 in x 0.85 in] footprint
- Wide supply voltage range, 6 ... 50 VDC
- 6,000 g_{pk} shock rated
- Conforming to **CE**

Description

The Type 8316A... capacitive accelerometer family utilizes a silicon Micro-Electro Mechanical System (MEMS) variable capacitance sensing element. Each axis consists of a very small inertial mass and a flexure element cantilever positioned between two plates. As the mass deflects under acceleration, the capacitance between these plates changes. AC excitation and synchronous amplitude demodulation circuitry contained in the accelerometer's internal signal conditioner provides an analog output signal proportional to the applied acceleration. This output signal is scaled as voltage and is proportional to the applied acceleration.

There are three housing/electrical interface options (AC, TA, TB), which determine the available output signal formats. The accelerometer is powered by a single regulated supply between 6 and 50 VDC.

The AC option is a hard anodized aluminum housing with an epoxy seal and an integral PVC cable. The maximum temperature range is 85 °C [185 °F]. The available output signal formats are bipolar 0 ± 4 V, single-ended 2.5 ± 2 V, and differential 0 ± 4 V or 0 ± 8 V. The sensing element and electronics are contained in this lightweight housing with an environmental seal and integral ground isolation.

Type 8316A...TA



Dimensions

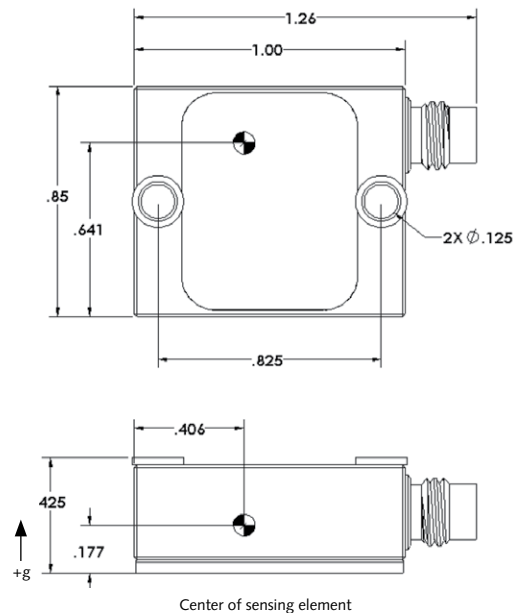

Outline drawing for Type 8316A...TA (units: mm [in])

The TA and TB options offer a welded titanium housing with either an industry standard 4 pin, 1/4"-28 connector or an integral PTFE jacketed cable. The maximum temperature range is 125 °C [260 °F] and the available output signal formats are bipolar 0 ± 4 V (with temperature output), single-ended 2.5 ± 2 V (with temperature output), and differential 0 ± 4 V or 0 ± 8 V. Temperature output is provided if external compensation of the output signal is desired. The sensing element and electronics are contained in a lightweight, welded titanium housing for a fully hermetic design with integral ground isolation. For adhesive mounting, the hard anodized plate at the bottom of the sensor provides ground isolation. For screw mounting, the sensors are supplied with integral isolation inserts in the screw holes to ensure a ground isolated mount in combination with the hard anodized plate on the bottom of the sensor.

8316A_003-324a-07.18

Application

Type 8316A... is an instrument-grade, single-axis accelerometer. It is well-suited for a wide variety of R&D and OEM applications requiring precision measurements and packaging designed for demanding application and handling needs.

In particular, the sensor design is optimized for low frequency applications common to Aviation/Aerospace, Automotive, Civil Engineering Structures, Seismic and other R&D studies. In particular, Aviation/Aerospace ground and flight testing often evaluates dynamics and structural vibration to assess performance parameters, reliability and integrity. Automotive laboratory and road testing evaluates system parameters such as vehicle ride, dynamics and structural analysis to assess performance parameters, reliability and durability. Civil engineering structures such as bridges are often evaluated for structural response to assess the integrity of the bridge to ensure safety. Seismic ground and structural testing are performed to measure the effects of earthquakes and other natural phenomena. The differential output versions are being used for railway comfort or conditional maintenance monitoring applications where halogen-free cables are requested as well. Other examples of R&D studies include human motion, robotics and platform motion control systems.

Mounting

The mounting surface must remain clean and flat in order to retain reliable and accurate measurements. The accelerometer can be directly attached to the test structure with the supplied screws or adhesive for a ground isolated mount. Several optional accessories are offered to mount Type 8316A... Type 8464K01 is an adhesive mounting base with two 4-40 threaded holes to mount the sensor with the supplied screws. Type 8464K02 is similar to Type 8464K01 and has a threaded 10-32 hole to provide a ground isolated stud mount. Type 8464K03 is also similar to Type 8464K01 and provides a magnetic mounting for the sensor. Type 8522 is a triaxial mounting cube which is used to provide a biaxial or triaxial solution for Type 8316A family of sensors. The instruction manual for Type 8316A... provides detailed information regarding mounting surface preparation.

Type 8316A ... TB



Dimensions

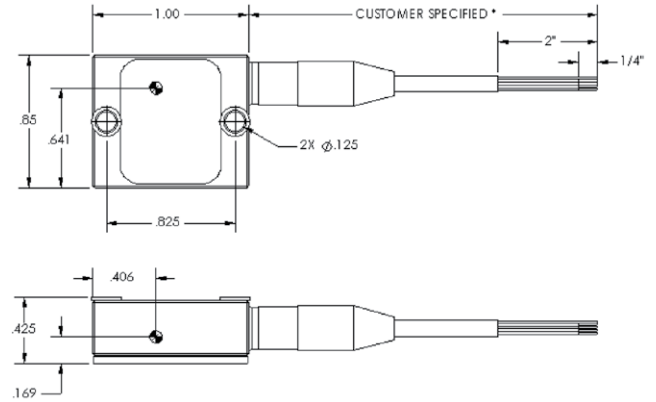

Outline drawing for Type 8316A...TB (units: mm [in])

Type 8316A ... AC



Dimensions

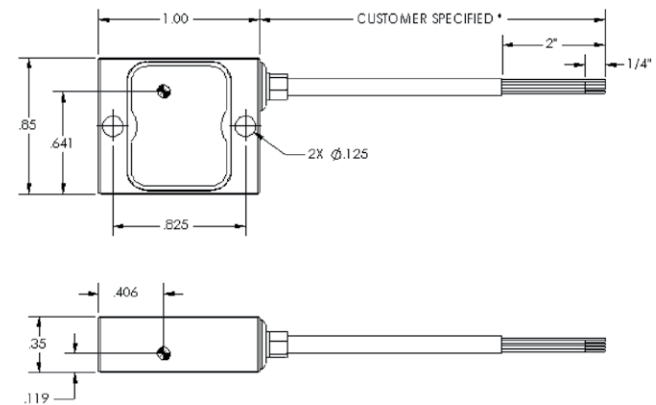

Outline drawing for Type 8316A...AC (units: mm [in])

8316A_003-324a-07.18

Technical data

Type	Unit	8316A2D0	8316A010	8316A030	8316A050	8316A100	8316A200
Acceleration range	g	±2	±10	±30	±50	±100	±200
Frequency response, ±5 %, min.	Hz	0 ... 250	0... 1,000	0... 1,500	0... 1,500	0... 1,500	0... 1,500
±5 %, typ.	Hz	0 ... 900	0 ... 2 000	0 ... 2 300	0 ... 2 700	0 ... 3 000	0 ... 3 500
±10 %, typ.	Hz	0 ... 1,000	0... 2,400	0... 3,000	0... 3,000	0... 3,500	0... 4,500
±3 dB, typ.	Hz	0 ... 1,150	0... 3,200	0... 4,000	0... 4,500	0... 5,000	0... 7,000
Damping ratio, nom.		0.7					
Sensitivity, ±5 % (ref. 100 Hz), Output Type A, 0±4 V FSO output	mV/g	2,000	400	133.3	80	40	20
Output Type B, 2.5±2 V FSO output	mV/g	1,000	200	66.6	40	20	10
Output Type C, 0±4 V FSO differential	mV/g	2,000	400	133.3	80	40	20
Output Type D, 0±8 V FSO differential	mV/g	4,000	800	266.6	160	80	40
Resonant frequency, nom.	kHz	1.2	3.2	5.2	6.5	8.5	11
Transverse sensitivity, typ. (max.)	%	1.0 (3.0)					
Sensitive axis misalignment, typ. (max.)	mrاد	10 (30)					
Amplitude linearity, max.	% FSO	±0.3					
Amplitude linearity, typ.	% FSO	±0.1					
Phase shift (max.) @ 0 Hz	degrees	0					
@ 10 Hz	degrees	2					
@ 100 Hz	degrees	10					
Noise density, 0 ... 100 Hz, typ. (max.)	mg _{rms} /√ Hz	0.007 (0.0085)	0.035 (0.042)	0.105 (0.125)	0.175 (0.210)	0.350 (0.420)	0.700 (0.840)
Noise 0 ... 100 Hz, typ.	mg _{rms}	0.070	0.350	1.050	1.750	3.500	7.000
Resolution (threshold), typ.	mg _{rms}	0.100	0.500	1.470	2.450	4.900	9.800

Electrical

0 g output, output Type (A; B; C; D)	mV	0 ±60 (A); 2,500 ±30 (B); 0±60 (C); 0 ±120 (D)					
Capacitive load, max.	μF	0.5					
Load resistance, min.	kΩ	30					
Output impedance, typ.	ohm	300					
Supply current, nom.	mA	4					
Supply voltage, temperature	VDC	6 ... 50 (≤100 °C [210 °F]); 6 ... 35 (≤110 °C [230 °F]); 6 ... 20 (<120 °C [250 °F]); 6 ... 12.5 (<125 °C [260 °F])					
Reverse polarity protection	yes/no	yes					

Environmental

Shock, (half sine, 200 μs)	g	6,000					
Random, (20 ... 2,000 Hz)	g _{rms}	20					
Storage temperature range	°C [°F]	-55 ... 125 [-65 ... 260] (TA or TB housing); -55 ... 85 [-65 ... 185] (AC housing)					
Operating temperature range	°C [°F]	-55 ... 125 [-65 ... 260] (TA or TB housing); -55 ... 85 [-65 ... 185] (AC housing)					
Temp. coeff. sensitivity, typ. (max.)	ppm/°C [ppm/°F]	±100 (±300) [±55 (±165)]					
Temp. coeff. sensitivity, typ. (max.)	%/°C [%/°F]	±0.01 (±0.030) [±0.006 (±0.017)]					
Temp. coeff. bias, typ. (max.)	mg/°C [mg/°F]	±0.1 (±0.8) [±0.06 (±0.4)]	±0.5 (±4) [±0.3 (±2.2)]	±1.5 (±12) [±0.8 (±6.6)]	±2.5 (±20) [±2.5 (±11)]	±5 (±40) [±2.8 (±22)]	±10 (±80) [±5.5 (±44)]

Operation of the sensor with supply voltage exceeding stated values at indicated temperatures will cause permanent damage to the sensor.

1 g = 9.80665 m/s², 1 in = 25.4 mm, 1 gram = 0.03527 oz, 1 lbf-in = 0.1129 N·m

Technical data (continued...)

Type	Unit	8316A2D0	8316A010	8316A030	8316A050	8316A100	8316A200
Temperature sensor							
Output @ 20 °C [68 °F]	V (E.U.) [V (U.S.)]				1.23 [1.23]		
Sensitivity	mV/°C [mV/°F]				-4.0 [-2.2]		
Accuracy	°C [°F]				±5 [±9]		
Physical							
Case	type	Titanium or Anodized Aluminum					
Mounting	type	4-40/M3					
Sealing	type	Environmental (AC housing); Hermetic (TA or TB housing)					
Ground isolation	yes/no	yes					
Weight (excluding cable)	grams	15 (TA or TB housing) /12 (AC housing)					
Cable length tolerance	m	±0.1					

NOTE: Operation of the sensor with supply voltage exceeding stated values at indicated temperatures will cause permanent damage to the sensor.
 1 g = 9.80665 m/s², 1 in = 25.4 mm, 1 gram = 0.03527 oz, 1 lbf-in = 0.1129 N·m

Included accessories: aluminum housing

- Mounting screw, M3x12 mm long
- Mounting screw, 4-40 UNC-2A x 1/2" long
- Fiber washer
- Mounting wax

Type/Art. No.
 431-0492-003
 431-0375-005
 434-0318-001
 8432

Included accessories: titanium housing

- Mounting screw, M3x14 mm long
- Mounting screw, 4-40 UNC-2A x 9/16" long
- Mounting wax

Type/Art. No.
 431-0492-004
 431-0491-002
 8432

Optional accessories

- Adhesive mounting base (off-ground) with two 4-40 female threaded holes on sensor side **Type** 8464K01
- Mounting base (off-ground) with two 4-40 female threaded holes on sensor side, one 10-32 threaded female through hole, with 10-32 stud **Type** 8464K02
- Magnetic mounting base **Type** 8464K03
- Triaxial mounting cube, with 10-32 UNF-2A x 1/2" screw and #10 washer, two 4-40 UNC-2A x 7/16" screws with washers **Type** 8522
- Baseplate conversion for backward compatibility to Type 8305/8310/8312 mounting pattern with 10-32 stud **Type** 8464K04
- Flexible shielded cable, silicone jacket (mates with Type 8315 with integral connector option) pigtail wires on opposite end (xx = length: 2, 5, or 10 meters – For other special length requests use 1534AK00sp) **Type** 1534AxxK00
- Extension cable, 4 pin 1/4-28 neg. to 4 pin 1/4-28 neg. PTFE jacket (1592A = 2m – For other special length requests use 1592A sp) **Type** 1592A
- Output cable, 4 pin neg., 1/4-28 neg. to pigtails PTFE jacket (1592M1 = 2m – For other special length requests use 1592M1 sp) **Type** 1592M1
- Halogen-free output cable, 4 pin neg., 1/4" neg. to pigtail (sp length only) **Type** 1592M2sp

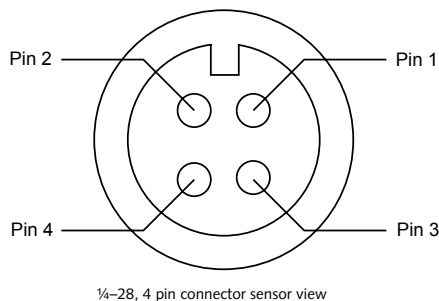

Ordering key

Type 8316A... [] [] [] []

Measuring range

±2 g	2D0
±10 g	010
±30 g	030
±50 g	050
±100 g	100
±200 g	200

Output Type

0±4 V FSO, no temperature output	A0
0±4 V FSO, with temperature output	AT
2.5±2 V FSO, no temperature output	B0
2.5±2 V FSO with temperature output	BT
0±4 V FSO, differential, no temp. output	C0
0±8 V FSO differential, no temp. output	D0

Housing/electrical interface

Anodized aluminum housing with Thermoplastic Elastomer Integral Cable (max. temperature to 85 °C [185 °F]); (output Types A0, B0, C0 and D0 only)	AC
Titanium housing with 4 pin connector (output Types AT, BT, C0 and D0 only)	TA
Titanium housing with integral cable (PTFE); (output Types AT, BT, C0 and D0 only)	TB

Cable length

















none	00
sp = length in meters (for AC and TB housing/electrical interface only)	sp

Electrical interface			Function-output		
A (pin)	B (Wire Color)	C (Wire Color)	Type A0, B0	Type AT, BT	Type C0, D0
1	Red	Red	Power	Power	Power
2 *	Black	Black	Return	Return	Return
3	Yellow	Green	N/C	Temperature	Output-
4	White	White	Output+	Output+	Output+
-	-	Orange	N/C	N/C	N/C
-	-	Blue	N/C	N/C	N/C
-	Shield	Shield	Case	Case	Case

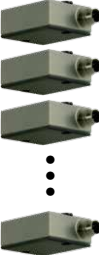
* not connected to cable shield

8316A_003-324a-07.18

Measuring chain

Measure	Connect	Amplify	Output	Analyze
 Type 8316A ... AC Type 8316A ... TB Integral cable	 Integral pigtail	customer supplied		 Read-out
 Type 8316A ... TA 4 pin pos.	 Type 1592M1/1534A... 4 pin neg. pigtail	customer supplied		 Read-out
 Type 8316A ... TA 4 pin pos.*	 Type 1592A ... 4 pin neg. 4 pin neg.	 Type 5210 Power supply	 Type 1511 BNC pos. BNC pos.	 Read-out
 Type 8316A up to 15	 Type 1592A... 4 pin neg. 4 pin neg.	 Type 5146A15 15-Channel Power supply	 Type 1511 BNC pos. BNC pos.	 Read-out
			 customer supplied	

* excludes C0 and D0 (differential) output Types

8316A_003-324a-07.18