



KISTLER

measure. analyze. innovate.

Biomechanics

**Measuring Systems
for Performance
Diagnostics and Gait
and Balance Analysis
in Sports, Medicine
and Ergonomics**



Kistler – Your Partner for Performance Improvement and Rehabilitation

Escalating athletic competitiveness can only be achieved through continuously improved training methods. An accurate knowledge of take-off forces at ski jumps or in athletics, and of force development involved in weightlifting or the martial arts helps set records time and again.

Our sense of balance is the product of a complex control system. Kistler force plates can be used for precise monitoring of shifts in weight and examination of the effects of diseases or medication.

Rehabilitation and prosthesis enhancement require very precise information on body movements, with the forces involved in walking and running playing a key role. Kistler force plates provide a precise and reliable record of these forces in every direction.

In addition to biomechanics measurement technology, as a Swiss company we also offer special sensors for measuring pressure, force, torque and acceleration,

as well as monitoring systems for mechanical production, the development and monitoring of internal combustion engines, automotive engineering and plastics processing.

Kistler's core competency is the development, production and use of sensors for measuring

- Pressure
- Force
- Torque
- Acceleration

With the aid of the company's expertise and electronic systems, measurement signals can be conditioned and used to analyze, control and optimize physical and other processes, and to boost product quality in manufacturing industry.

Year after year Kistler invests 10 % of its sales in R&D to facilitate technically innovative yet cost-effective state of the

art solutions. With a combined workforce of around 1 050, the Kistler Group is the market leader in dynamic measurement technology.

25 group companies and 30 distributors worldwide ensure close contact with the customer, individualized application engineering support and short lead times.

Kistler places a great deal of value on the exchange of know-how and close collaboration with leading research institutes, hospitals and sports performance centers worldwide.

This is the only way of developing reliable measuring instruments that fully meet the most stringent requirements.



Kistler is therefore a founder member of the International Society of Biomechanics (ISB), whose activities it supports as principal sponsor.



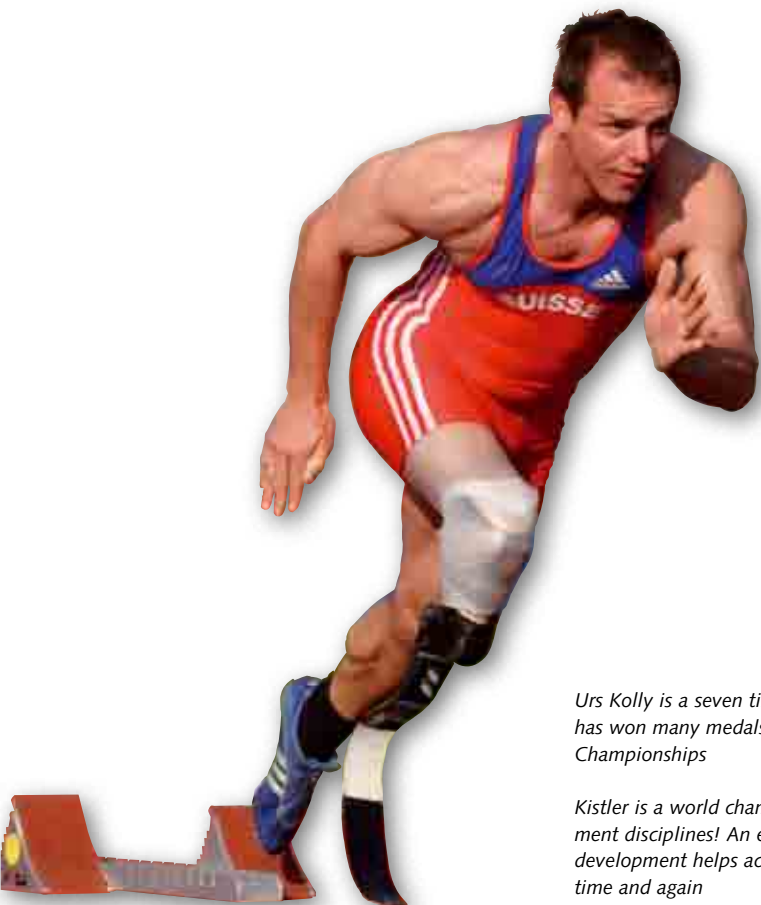

www.isbweb.org



Urs Kolly is a seven times Paralympic winner and has won many medals in European and World Championships

Kistler is a world champion in various measurement disciplines! An exact knowledge of force development helps achieve top-class performances time and again

Contents

Measurement Technology in Practice	Motion and Gait Analysis Sport and Performance Diagnostics Ergonomics and General Biomechanics	4 ... 5 6 ... 7 8 ... 9	
The Piezoelectric Effect		10	
Measuring Chains with Piezoelectric Sensors		11	
Advantages of Piezoelectric Force Plates		12	
Worthwhile Investment without Compromises		13	
Sensor Portfolio Biomechanics – General		14	
Product Overview (Applications)		16	
Product Details/Product Range			
Measuring:	Force Plates	17	
Amplifying:	Charge Amplifiers/Control Units	21	
Analysis:	Software	22	
Connecting:	Cables/Connectors	24	
Accessories:	Mounting Frames/Walkways	26	
Why Kistler Force Plates?		27	

KISTLER
measure. analyze. innovate.

measure.

Kistler develops and produces high quality measurement technology. Its core competence is sensor-related expertise.

analyze.

The analysis of sensor data calls for in-depth knowledge of the processes involved. Kistler has acquired this in major fields of application and is able to offer complete analysis systems.

innovate.

Kistler products are developed in close cooperation with key customers and universities. This inspires product innovation and technological progress.

Measurement Technology in Practice



Gait analysis laboratory with infrared cameras and force plates Type 9286BA

Ever since Kistler force plates were first introduced back in 1969, they have consistently proved their worth as precise and reliable measuring instruments. They are a routinely used and indispensable tool in the motion analysis laboratories of leading specialists in biomechanics throughout the world. Their versatility and long service life have always made them a sound investment.

Their high sensitivity and extremely wide measuring range permitting one and the same plate to measure with equal precision forces both large and small. Their simple and dependable interfaces guarantee maximum long-term compatibility with other systems employed in motion analysis.

Fine resolution for gait analysis

Rehabilitation and the improvement of joint implants and prostheses demand a very precise understanding of body movements. The forces involved in walking and running play a key role here.

As well as measuring ground reaction forces precisely and reliably, Kistler force plates exploit inverse dynamics to provide a sound basis for calculating forces and moments. The high level of accuracy of these force plates detects minute changes and asymmetries in the gait. They therefore help practitioners reach correct diagnoses, adjust prostheses and document the rehabilitation process.



Special-sized force plates, e.g. for stairs (270x500x35 mm, top right) or for experiments with small animals (120x200x35 mm, top), are developed to customer requirements



Multicomponent force plate Type 9260AA...

Motion and Gait Analysis



Source: Royal Veterinary College, University of London, UK

Maximum precision for equilibrium analysis

The human sense of balance is the product of a complex control system. In addition to precise force measurement, the special design principle of some Kistler force plates allows very accurate monitoring of shifts in weight and examination of the effects and progress of diseases or medication.

Kistler force plate Type 9286BA was developed specifically for gait and balance analysis. Even under a heavy load it permits measurement of extremely small changes in force and vibrations that can yield information about the condition of the neuromuscular motion control system.

Analysis of the gait of horses on six force plates Type 9287BA installed on the ground

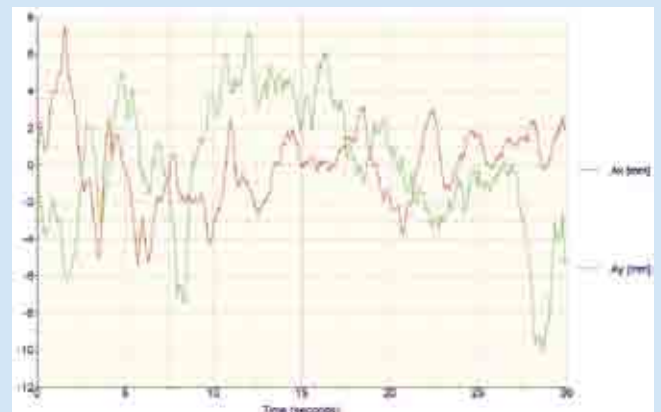
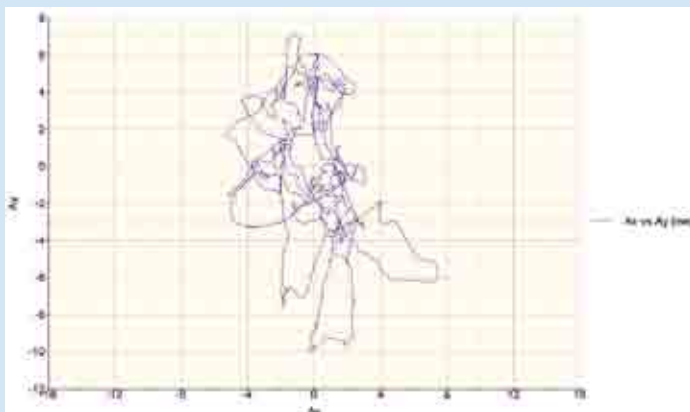

Equilibrium analysis through accurate determination of the center of pressure (COP); left: view of A_x against A_y ; right: A_x and A_y against time



Force plate Type 9286BA is characterized by its very high COP accuracy, low overall height of just 35 mm and ease of installation on the floor

Measurement Technology in Practice

In sports, winning performances can only be achieved through continuously improved methods of highly controlled training. By analyzing the forces that athletes generate at various points, it is possible not only to draw conclusions relating to performance at a particular moment but also to record differences in the efficiency of various techniques and to modify the training program accordingly.

A precise knowledge of force development consistently helps prepare the way for record levels of performance. This applies equally well to technically demanding sports like golf, climbing and ski-jumping, but also to sports in which force (e.g. for explosive force) or energy (e.g. for endurance) need to be maximized or optimized.

Versatility means flexibility of application

The high preload and linearity of their piezoelectric sensors allow Kistler force plates to measure very accurately even under high initial loads. They can therefore be installed in any position and equipped with additional equipment or coverings without their precision or zero point being affected. The high natural frequency, extremely wide usable measuring range and high load capacity of the plates make it possible to capture even highly dynamic processes in the martial arts, Olympic lifting or athletics.



Force plate Type 9287BA for analysis of running and jumping in athletics



Source: Bergisel Betriebsgesellschaft m.b.H., Austria

Ski jump with customized 3-component force plates for measuring forces on the jump-off platform



Sports and Performance Diagnostics

Performance diagnostics during natural movement

Kistler force plates provide an ideal instrument for objective measurement of take-off forces in performance diagnostics and biomechanics.

Quattro Jump is a complete mobile analysis system for testing the performance level of the legs in relation to power, coordination and stamina. In contrast to isokinetic systems or other jump tests the athlete moves completely naturally in a way that reflects his or her condition and coordination. Multiple jumps can be analyzed just as effectively as single jumps in order to provide objective, reliable and repeatable measurement results.

The reasonably priced easy-to-understand Quattro Jump quickly and accurately provides sports medicine physicians, trainers and athletes with the information needed to optimize training.

It is useful for:

- Performance and fitness testing and benchmarking
- Control and monitoring of training
- Matching the intensity of training to an injury



Source: Prof. Dr. Erich Müller, Interfaculty Department of Sports and Movement Science, University of Salzburg, Austria

Complete 3D motion analysis with determination of forces and moments in the knee joint during carved and conventional ski turns with the aid of four customized multicomponent force plates. The dynamometers are mounted between ski and binding/boot



Quattro Jump Type 9290BD consists of a portable force plate developed for measuring take-off force. For different jumps it measures the take-off force, which is then analyzed on the connected computer

Measurement Technology in Practice

Kistler provides a broad range of piezo-electric sensors for applications of every kind in research and industry. They are all characterized by an extremely wide measuring range, high linearity and stability and very compact size. This impressive selection is supported by a sales and service network providing vital expertise throughout the world.

Extensive portfolio of sensors for biomechanics

Our product line includes over 1 000 different force, acceleration, pressure and torque sensors for measuring tasks of all kinds. Force and movement are key factors in obtaining a clearer picture of the complex processes involved in biomechanics and a more precise definition of the properties of the materials. Because of Kistler's decades of accumulated experience in biomechanics, our experts are able to provide you with reliable and objective advice in selecting extremely versatile sensors and systems best suited for your special measurement task or application.



Source: © h/p/cosmos sports & medical gmbh, www.h-p-cosmos.com

Medical treadmill ergometer



Source: Dr. Michael Weishaupl, Sports Medicine Performance Center of the Equine Veterinary Clinic, University of Zurich, Switzerland

Instrumented horse treadmill with 18 Kistler force sensors

Instrumented treadmills

An instrumented horse treadmill was developed in the Sports Medicine Performance Center of the Equine Veterinary Clinic of the University of Zurich and constructed in conjunction with Kistler and the horse treadmill manufacturer Graber AG. The treadmill has 18 specially manufactured Kistler sensors and one 18-channel charge amplifier.

The "H/P/Cosmos Gaitway II" medical treadmill ergometer is based entirely on measurement technology and analysis software from Kistler and meets all of the legal standards relating to safety and medical devices. With force plates mounted in its bed, the treadmill allows quick and reliable clinical walking and galloping gait analysis.

High-sensitivity force sensors

Even such an extraordinary feat of measurement as determining the modulus of elasticity of a single trabecula of bone is possible with Kistler sensors. This structure between 1 and 2 mm in length and 50 ... 100 microns in thickness was deformed with the aid of a fine (50 micron) nylon thread in the natural network of trabecular bone. Force and deformation are measured to test the quality of the material forming the bone. High-sensitivity force sensor Type 9205 with a threshold of $<0,5 \cdot 10^{-3}$ N enabled measurement of the very low forces of up to 100 ... 1 500 mN.



Determination of modulus of elasticity of single trabecula of bone

Source: Prof. Dr. Edgar Stüssi, Institute of Biomechanics, ETH Zürich, Switzerland

Ergonomics and General Biomechanics

Hand force measurement protects against strain

The forces we have to exert with our hands when working with heavy equipment and objects can be accurately measured over an extended period using a multicomponent hand force dynamometer. A knowledge of these forces for different activities helps in the diagnosis of occupational diseases and suggestion of preventive measures to reduce loads. As with the use of force plates, the measured force vectors can be used to calculate the load on the spine and for other biomechanical evaluations.

The hand dynamometers Type 9809A were developed by the Institute for Occupational Safety and Health (IFA, former BGIA) of the German employer's liability insurance association (Berufsgenossenschaften), using products including force sensors Type 9017B from Kistler.



Source: Institute for Occupational Safety and Health of the German Social Accident Insurance (www.dguv.de/ifa)



Source: Institute for Occupational Safety and Health of the German Social Accident Insurance (www.dguv.de/ifa)

Measurement of hand forces in different situations



Hand force measuring system Type 9809A for ergonomics, biomechanics and occupational health & safety

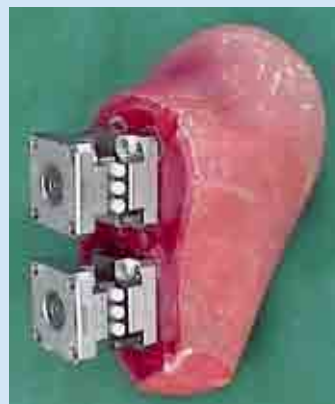
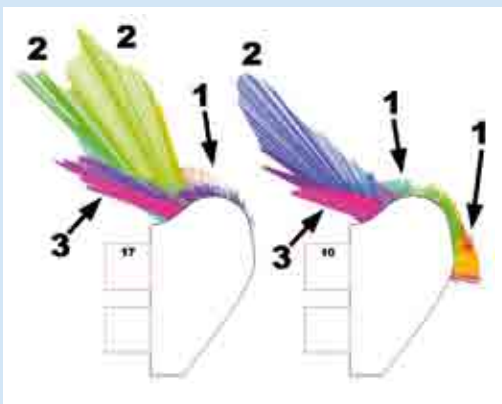

Determination of point of application of force and force vector on a climbing grip instrumented with two force sensors Type 9327A during a National Climbing Championship in Singapore

Source: Prof. Franz Konstantin Fuss: Nanyang Technological University, Division of Bioengineering, Sports Engineering Research Team, Singapore; "Sports Technology", 2008



3-component force link 9327A for measuring tension and compression

The Piezoelectric Effect

Many crystals generate an electric charge when subjected to mechanical stress. This physical correlation has become known throughout the world as the piezoelectric effect. In 1950, Walter P. Kistler was granted the patent that heralded the breakthrough of wide industrial application for piezoelectric measurement. This method of measurement is the perfect answer to particularly extreme requirements in terms of geometry, temperature range and dynamics.

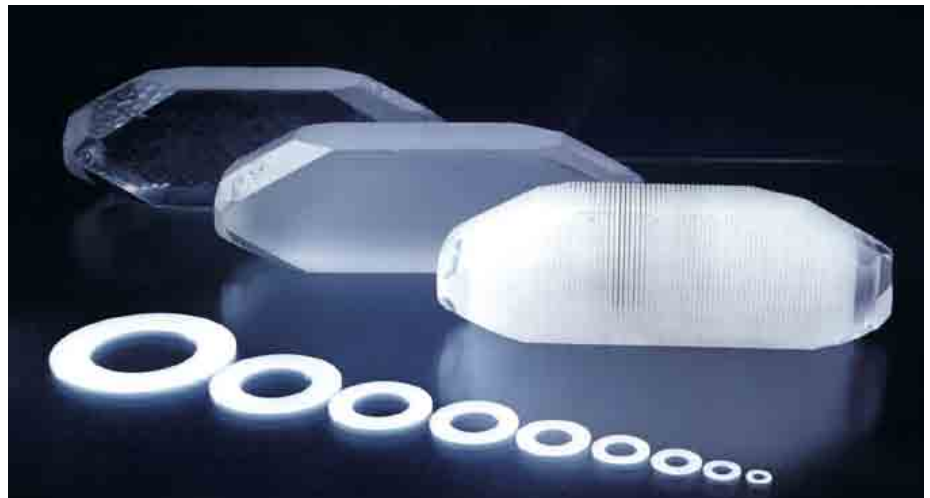

From quartz crystal to crystal washer

The piezoelectric effect – the prefix "piezo" comes from the Greek "piezein", to press – was discovered in 1880 by the Curie brothers. They found that the surfaces of certain crystals – including quartz – become electrically charged when the crystal is mechanically loaded. This electric charge is exactly proportional to the force acting on the crystal. It is measured in picocoulombs ($1 \text{ pC} = 10^{-12} \text{ coulombs}$).

Depending on the orientation of the polar axes of the crystal with respect to the applied force, two different effects relevant to biomechanics can be discerned

- Longitudinal
- Shear

Longitudinal effect

The charge produced by the longitudinal effect is developed on and can be collected from the surfaces to which the force is applied. Its magnitude Q in the case of the longitudinal effect depends only on the applied force F_x and not significantly on the dimensions of the crystal washers. The only way of increasing this charge is to connect several washers mechanically in series and electrically in parallel. The direction in which the crystal is sliced determines the properties and hence the application of the force link.

Piezoelements sliced to exhibit the longitudinal effect are sensitive to compression

forces and are therefore mainly suitable for simple, robust sensors for measuring forces.

Shear effect

As with the longitudinal effect, the piezoelectric sensitivity involved in the shear effect is independent of the size and shape of the piezoelement. The electric charge also develops on the loaded surfaces of the element in this case.

Shear-sensitive piezoelements are used for sensors measuring shear force, torque, strain and acceleration.

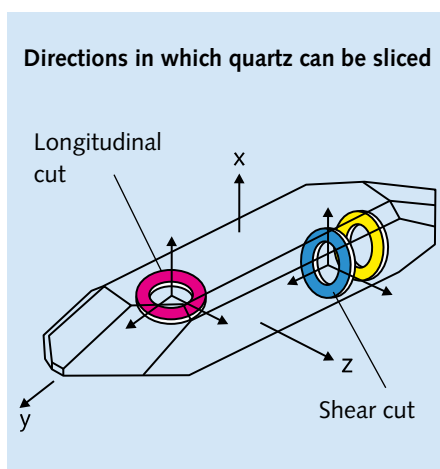

Directions in which quartz can be sliced

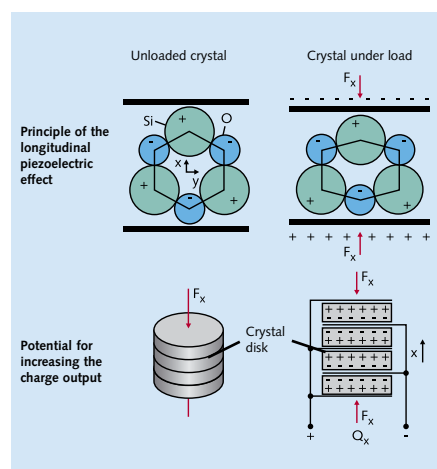

Principle of longitudinal effect

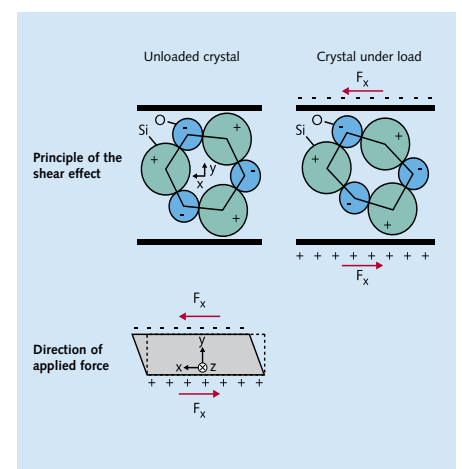

Principle of shear effect

Measuring Chains with Piezoelectric Sensors

Types of Sensor

Quartz washers with piezoelectric properties can be arranged in sensors to enable measurement of one or more force components or a torque vector. For use in biomechanics, Kistler offers the following sensors based on piezoelectrics:

- Single-component force sensors
- Multicomponent force sensors
- Multicomponent force plates and
- A wide range of other sensors for measuring strain, torque, pressure and acceleration

Single-component force sensors

Single-component force sensors, which are available in a wide variety of forms, are the design most suitable for measuring forces in a defined spatial direction.

Multicomponent force sensors

The piezoelectric measuring principle is also ideal for manufacturing multicomponent force sensors. The design of the sensor is similar to the single-component load washer. A pair of quartz washers sliced to exploit the longitudinal effect measures the normal component F_z , and one of each of a pair of washer sliced for the shear effect measures the two shear components F_x and F_y .

As shear forces can only be transferred by friction, mounted multicomponent force sensors must always be under sufficiently high mechanical preload.

When mounted in dynamometers or force plates, multicomponent force sensors are usually employed in groups or three of four with the same sensitivity rather than individually. Clamping a load washer be-

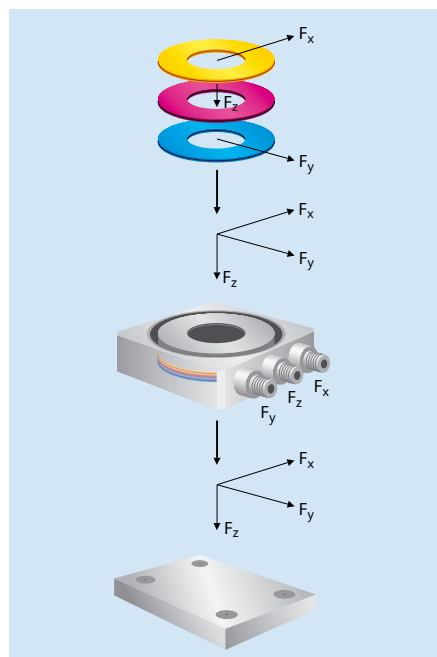

Principle of operation of multicomponent force plate

between two special nuts gives rise to what is called a force link. This preloaded sensor can be used to measure tension and compression forces, for example in a linkage. Preloaded sensors are supplied calibrated and can be easily mounted ready to be used immediately for measurement.

Charge Amplifiers

Charge amplifiers convert the charge output by a piezoelectric force sensor into a proportional voltage that can be used as an input variable for analysis or control systems. Most charge amplifiers from Kistler allow setting of the sensitivity and measuring range of the sensor to

allow use of one and the same sensor to measure very small through to very large quantities.





Calibration

Kistler sensors are calibrated for different measuring ranges prior to being dispatched from the factory. All of the relevant data is shown on the supplied calibration certificate. This ensures the output signal of the sensor can be converted accurately and reliably into the actual measurand (e.g. force). Kistler runs Swiss Calibration Service Laboratory No. 049, which is accredited to ISO 17025. The Kistler quality management system is certified to ISO 9001.

DAQ System and Software

Kistler supplies a variety of powerful data acquisition systems with USB 2.0 ports or a PCI bus and its analysis software BioWare®, which is used to set charge amplifier parameters with great ease. The application programming interface (API) BioWare Dataserver.dll Type 2873 for Kistler DAQ systems is available for download free of charge. All systems measure both highly dynamic processes and very small variables, and can also be used to acquire any analog signals. Connection cables and external control devices integrate force plates from Kistler into data acquisition and motion analysis systems from other manufacturers.

Configuration of typical measuring chain with Kistler DAQ System Type 5691A1

			
Force plate with charge amplifier Type 9281CA	Connection cable Type 1759A...	DAQ-system (USB 2.0) Type 5691A1	Laptop (provided by user) with BioWare® software

Advantages of Piezoelectric Force Plates

Piezoelectric force, torque and strain sensors are very compact and rigid, and offer a measuring range of up to six decades, a high natural frequency and low interference sensitivity. They cover a wide temperature range, are overload-protected and offer long-term stability as well as freedom from fatigue. Piezoelectric sensors are ideal for almost all areas of application, particularly for the type of dynamic and highly sensitive processes encountered in biomechanics.

The operating principle of quartz crystal sensors in Kistler force plates means that compared with sensors with strain gages they offer decisive advantages, most of which are attributable to their comparatively high rigidity.

Sturdiness, overload protection and long-term stability

Piezoelectric force plates are very compact for an instrument with such a wide measuring range. Their rigidity makes them robust and gives them a high factor of safety against overload. Even after millions of load cycles and frequent thermal cycling the plates show no sign of fatigue or sensitivity drift. With correct use their service life is virtually unlimited.

High natural frequency and damping

The high rigidity of quartz crystal sensors is reflected in the very high overall stiffness of Kistler force plates, which results in a very high natural frequency and damping in all three directions of measurement. They are therefore particularly suitable for accurate measurement of highly dynamic processes such as the motion involved in sports.

High sensitivity over wide measuring range

Unlike strain gages, quartz crystal sensors have a wide measuring range of up to six decades, as their sensitivity, threshold and resolution are not linked to the stiffness of elastically deformable structures and hence to a limited measuring range. Irrespective of the measuring range and any initial load, piezoelectric sensors can also be used to measure very small forces, such in minute variations in a large base load.

Exact zero – No offset

With piezoelectric sensors the zero is redetermined prior to each new measurement process. Resetting physically tares the sensors by discharging any electric charge generated by factors such as an initial load. This automatically eliminates the effect of all static and slowly changing boundary conditions (such as mounting position, weight of supported elements and temperature fluctuations) without affecting the measurement accuracy.

Balance analysis and static measurements

Due to their low threshold, high sensitivity and very high accuracy Kistler force plates are ideal for balance analyses and other quasistatic measurements taken over a period of several minutes. However, piezoelectric sensors are not suitable for truly static measurements



Easy installation and versatility: Two force plates Type 9281EA on frame with variable mounting positions

Benefits

Advantages of piezoelectric force plates over strain gage counterparts

- + Extremely wide measuring range of up to six decades
- + Sensitivity, threshold and resolution independent of measuring range
- + High rigidity and virtually displacement-free measurement
- + High natural frequency and damping
- + Overload protection, freedom from fatigue and long-term stability
- + Virtually unlimited service life
- + Low sensitivity to interference
- + Compact setup for wide measuring range

over several hours or days, as charge amplifiers always exhibit a slight drift. Drift is defined as an undesirable change in output signal over an extended period of time that is not a function of the measurement. Charge amplifier drift is unavoidable because there is no material available offering infinite insulation.

Even the best transistors still exhibit minimal leakage currents of a few femtoamperes (10^{-15} A), and even the best insulators only have resistances of 10^{14} Ω . The maximum drift of Kistler charge amplifiers is approximately 0,03 pC/s, which in a force plate corresponds to a maximum unwanted change in the signal of $<\pm 10$ mN/s for F_z (or $<\pm 5$ mN/s for F_x, y).

Worthwhile Investment without Compromises

Kistler force plates measure extremely accurately and provide reliable, reproducible results to guaranteed specifications over their entire service life. They quickly pay for themselves, as they are built to last and cover a wide range of applications and extensive measuring range without compromising on measurement accuracy.

Easy installation and mobility

In contrast to conventional designs the force plate Type 9286B... for gait and balance analysis does not have to be installed on a frame; it can just be used on any flat surface without incurring additional costs. The plate's low overall height of just

35 mm and weight of under 18 kg allows versatile, mobile application. For very dynamic applications Kistler force plates are mounted on an installation frame that is molded into the foundation to guarantee their full potential can be exploited. A lightweight aluminum sandwich cover plate keeps the force plates Type 9281E... and 9287C... relatively light at 16 or 25 kg. This makes installation and transport easier, so that Kistler force plates can be used not only in different mounting positions but also in various measurement locations.

Cost effectiveness through versatility

While force plates with strain gage sensors are limited by their elastically deformable

structures to a particular, optimal measuring range, Kistler force plates with quartz crystal sensors can accurately measure both very small and very large forces within their structural load capacity. Very small forces can also be measured under a high initial load. It is therefore not necessary to purchase different Kistler force plates to cover several measuring ranges. Moreover, quartz crystal sensors are characterized by extreme robustness and durability.

Due to their high natural frequency in all three directions of measurement (f_{rx} , f_{ry} and f_{rz}), high natural damping and rapid response, Kistler force plates always represent even highly dynamic processes correctly.

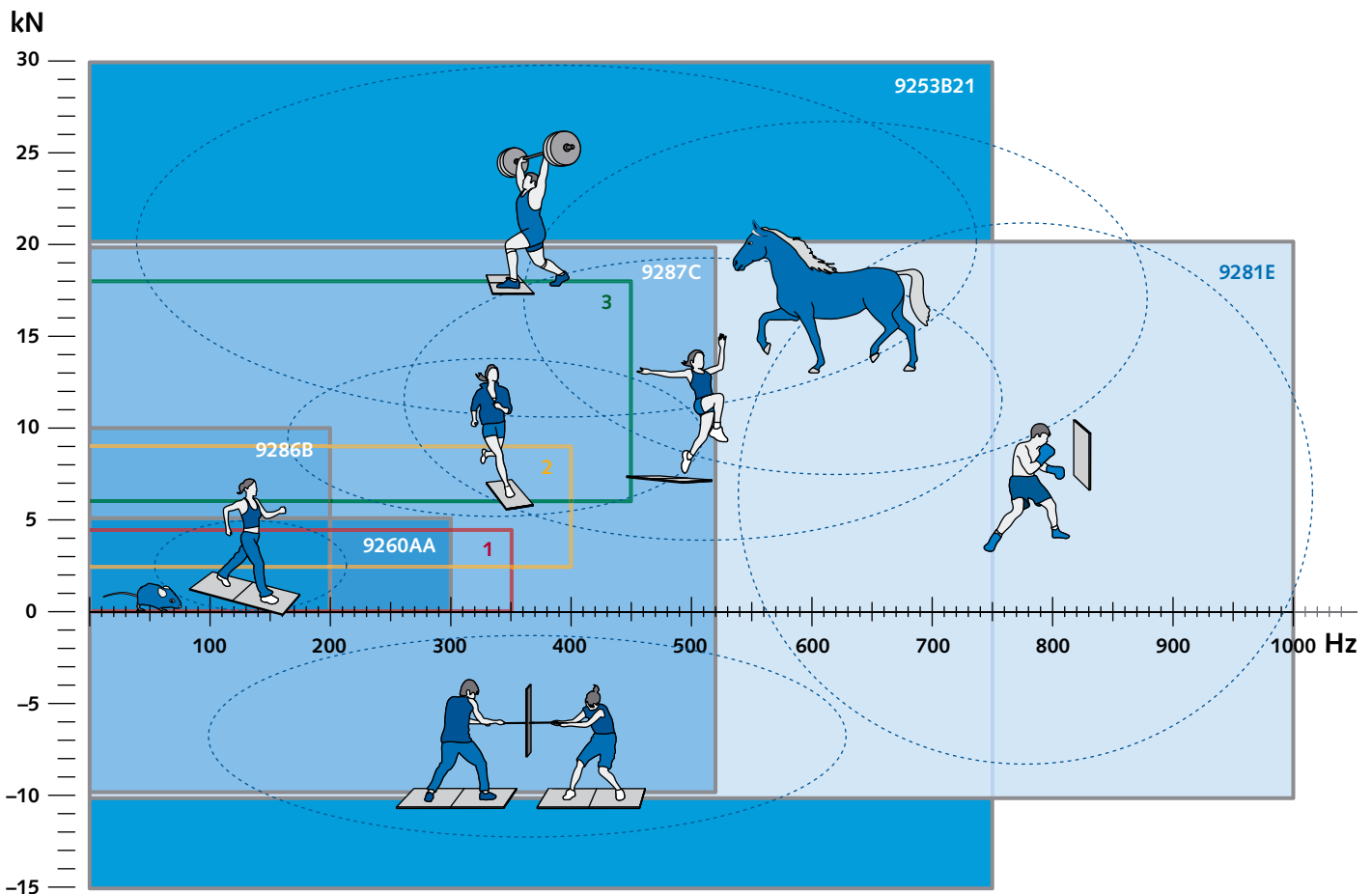

Kistler force plates are versatile and suitable – depending on maximum load capacity and natural frequency – for a wide variety of applications. In comparison three typical force plates with strain gage (4, 5, 9 and 18 kN) and only limited application fields

y-axis: maximum load capacity
x-axis: lowest natural frequency from f_{rx} , f_{ry} and f_{rz}





Typical force plates with strain gages:



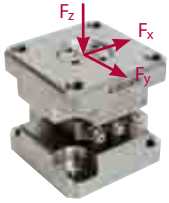

- 1 strain gage F_z max. 4,5 kN
- 2 strain gage F_z max. 9 kN
- 3 strain gage F_z max. 18 kN

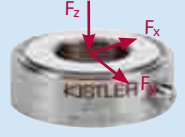
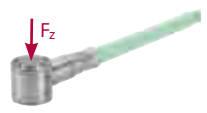
Sensor Portfolio for Biomechanics – General

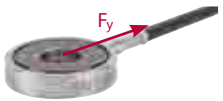
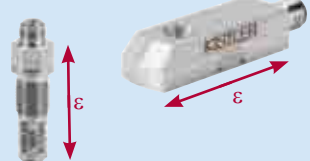
Force and movement are key factors in gaining a clearer idea of the complex processes of biomechanics and a more precise definition of material characteristics.

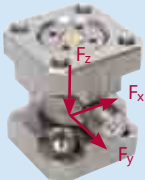
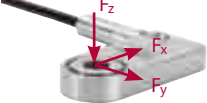
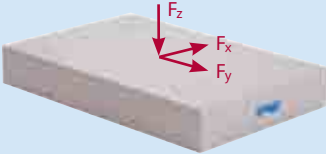
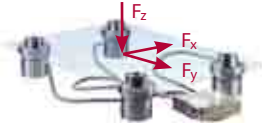
Kistler's range includes over 1 000 different force, acceleration, pressure and torque sensors for measuring tasks of all kinds.

Description	Range	Product
<p>Force sensors Quartz sensors from Kistler can be used for direct and indirect measurement of forces in one or more directions.</p>	1 mN ... 20 MN	
<p>Sensors for very small forces The special design of these sensors provides sensitivity 30 times higher than load washers.</p>	0,5 ... 500 N	
<p>Load washers Kistler robust load washers are extraordinarily versatile in application.</p>	2,5 ... 1 200 kN	
<p>Load washers Kistler 3-component load washers measure the three orthogonal force components independently.</p>	2 ... 60 kN	
<p>Miniature sensors The extremely small size, high natural frequency and integral connecting cable enable use under critical mounting conditions.</p>	0,5 ... 2,5 kN	
<p>1-component force link The easily mounted preloaded force link is calibrated ready for immediate measurement of tension and compression forces.</p>	2,5 ... 120 kN	
<p>Shear elements These very flat and small elements allow extremely flexible mounting.</p>	0,9 ... 4 kN	
<p>Strain sensors (longitudinal/transverse) This type of sensor measures the strain of the structure in which it is mounted and provides indirect measurement of very high forces.</p>	-600 ... 600 $\mu\epsilon$, -1 500 ... 1 500 $\mu\epsilon$	

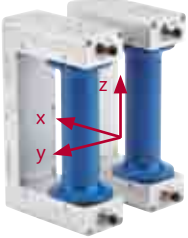
Description	Range	Product
<p>3-component force link The easily mounted preloaded force link is calibrated ready for immediate measurement of the three force components.</p>	2 ... 150 kN	
<p>With built-in electronics 3-component load washers with built-in charge amplifier and output voltage (5 V).</p>	-5 ... 5 kN	
<p>Multicomponent force plate This plate uses 4 multicomponent load washers to enable measurement of the orthogonal forces, the moments and the point of application of the force.</p>	-10 ... 30 kN	
<p>Kit Ready-to-connect kit for assembling multicomponent force plate.</p>	-20 ... 40 kN	
<p>Torque and force Reaction torque sensor capable of measuring additional acting forces.</p>	F_z -10 ... 10 kN, -20 ... 20 kN	
<p>Pressure</p>	0,1 ... 10 000 bar	
<p>Acceleration</p>	3 μ g ... 100 000 g	
<p>Systems</p>	-1 ... 1 kN	

More detailed information and data sheets are to be found in the Product Finder on Kistler's website.

Measuring

Force Plates

Multicomponent Force Plate

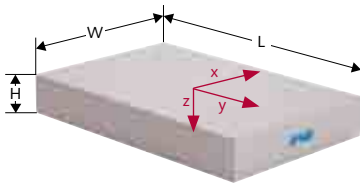

Type 9281E...

Technical Data			Type 9281E...
Measuring range	F_x, F_y	kN	-10 ... 10
	F_z	kN	-10 ... 20
Overload	F_x, F_y	kN	-15/15
	F_z	kN	-10/25
Linearity	% FSO		<±0,2
Hysteresis	% FSO		<0,3
Crosstalk	$F_x \leftrightarrow F_y$	%	<±1,5
	$F_x, F_y \rightarrow F_z$	%	<±1,5
	$F_z \rightarrow F_x, F_y$	%	<±0,5 (inside sensor rectangle)
Rigidity	x-axis ($a_y = 0$)	N/μm	≈250
	y-axis ($a_x = 0$)	N/μm	≈400
	z-axis ($a_x = a_y = 0$)	N/μm	≈30
Natural frequency	$f_n(x, y)$	Hz	≈1 000
	$f_n(z)$	Hz	≈1 000
Operating temperature range		°C	0 ... 60
Weight		kg	16
Dimensions	LxWxH	mm	600x400x100
Degree of protection	EN 60529:1992		IP65

Characteristics

Extremely wide measuring range, excellent measuring accuracy, high natural frequency, versatile, threshold $F_z < 250$ mN.

Application

This force plate is designed specifically for use in basic research, sports and gait analysis. The plate can be mounted in any position.

Accessories

16ch DAQ system Type 5691A1
64ch DAQ system Type 5695A...
see data sheet for further details

Data sheet 9281E_000-711

Large Multicomponent Force Plate

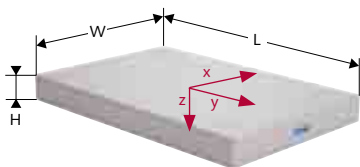

Type 9287C...

Technical Data			Type 9287C...
Measuring range	F_x, F_y	kN	-10 ... 10
	F_z	kN	-10 ... 20
Overload	F_x, F_y	kN	-13/13
	F_z	kN	-10/25
Linearity	% FSO		<±0,2
Hysteresis	% FSO		<0,3
Crosstalk	$F_x \leftrightarrow F_y$	%	<±1,5
	$F_x, F_y \rightarrow F_z$	%	<±1,5
	$F_z \rightarrow F_x, F_y$	%	<±0,5 (inside sensor rectangle)
Rigidity	x-axis ($a_y = 0$)	N/μm	≈150
	y-axis ($a_x = 0$)	N/μm	≈200
	z-axis ($a_x = a_y = 0$)	N/μm	≈30
Natural frequency	$f_n(x, y)$	Hz	≈750
	$f_n(z)$	Hz	≈520
Operating temperature range		°C	0 ... 60
Weight		kg	25
Dimensions	LxWxH	mm	900x600x100
Degree of protection	EN 60529:1992		IP65

Characteristics

Extremely wide measuring range, excellent measuring accuracy, high natural frequency, versatile, threshold $F_z < 250$ mN, large dimensions.

Application

This force plate is designed specifically for use in basic research, sports and gait analysis. The plate can be mounted in any position.

Accessories

16ch DAQ system Type 5691A1
64ch DAQ system Type 5695A...
see data sheet for further details

Data sheet 9287C_000-712

Measuring

Force Plates

Multicomponent Force Plate

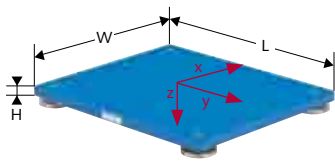

Type 9260AA...

Technical Data			Type 9260AA6/9260AA3
Measuring range	F_x, F_y	kN	-2,5 ... 2,5
	F_z	kN	0 ... 5
Overload	F_x, F_y	kN	-3/3
	F_z	kN	0/8
Linearity	%FSO		<±0,5
Hysteresis	%FSO		<0,5
Crosstalk	$F_x \leftrightarrow F_y$	%	<±2,5
	$F_x, F_y \rightarrow F_z$	%	<±2,5
	$F_z \rightarrow F_x, F_y$	%	<±0,5 (inside sensor rectangle)
Max. COP error	a_x	mm	≈2
	a_y	mm	≈2
Natural frequency	$f_n(x, y)$	Hz	≈400/500
	$f_n(z)$	Hz	≈200/300
Operating temperature range	°C		10 ... 50
Weight	kg		8,6/5,5
Dimensions	LxWxH	mm	600x500x50/298,5x500x50
Degree of protection	EN 60529:1992		IP52

Characteristics

Excellent accuracy of center of pressure (COP), available in two different sizes, easy mounting, versatile installation, portable usage.

Application

The force plate is designed specifically for use in gait and balance analyses and has a built-in charge amplifier compatible with all of the common motion analysis systems.

Accessories

16ch DAQ system Type 5691A1
64ch DAQ system Type 5695A...
Walkway Type 9418A...
Installation frame Type 9428A...
see data sheet for further details

Data sheet 9260A_000-729

Mobile Multicomponent Force Plate

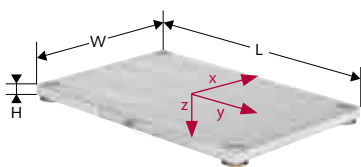

Type 9286B...

Technical Data			Type 9286B...
Measuring range	F_x, F_y	kN	-2,5 ... 2,5
	F_z	kN	0 ... 10
Overload	F_x, F_y	kN	-3/3
	F_z	kN	0/12
Linearity	%FSO		<±0,2
Hysteresis	%FSO		<0,3
Crosstalk	$F_x \leftrightarrow F_y$	%	<±1,5
	$F_x, F_y \rightarrow F_z$	%	<±2,0
	$F_z \rightarrow F_x, F_y$	%	<±0,5 (inside sensor rectangle)
Rigidity	x-axis ($a_y = 0$)	N/μm	≈12
	y-axis ($a_x = 0$)	N/μm	≈12
	z-axis ($a_x = a_y = 0$)	N/μm	≈8
Natural frequency	$f_n(x, y)$	Hz	≈350
	$f_n(z)$	Hz	≈200
Operating temperature range	°C		0 ... 60
Weight	kg		17,5
Dimensions	LxWxH	mm	600x400x35
Degree of protection	EN 60529:1992		IP63

Characteristics

Excellent accuracy of center of pressure (COP), very wide measuring range, easy mounting, flexible, portable usage, threshold $F_z < 250$ mN.

Application

This force plate is designed specifically for use in gait and balance analysis. Flexible, portable usage.

Accessories

16ch DAQ system Type 5691A1
64ch DAQ system Type 5695A...
Walkway Type 9401B...
see data sheet for further details

Data sheet 9286B_000-713

Measuring

Force Plates

Multicomponent Force Plate with Glass Top Plate

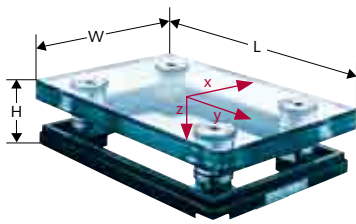

Type 9285BA

Technical Data			Type 9285BA
Measuring range	F_x, F_y	kN	-2,5 ... 2,5
	F_z	kN	0 ... 10
Overload	F_x, F_y	kN	-6/6
	F_z	kN	0/12
Linearity	%FSO		<±0,5
Hysteresis	%FSO		<0,5
Crosstalk	$F_x \leftrightarrow F_y$	%	<±2
	$F_x, F_y \rightarrow F_z$	%	<±2
	$F_z \rightarrow F_x, F_y$	%	<±0,5
Rigidity	x-axis ($a_y = 0$)	N/μm	≈120
	y-axis ($a_x = 0$)	N/μm	≈115
	z-axis ($a_x = a_y = 0$)	N/μm	≈25
Natural frequency	$f_n(x, y)$	Hz	≈300
	$f_n(z)$	Hz	≈500
Operating temperature range		°C	0 ... 60
Weight		kg	45
Dimensions	LxWxH	mm	600x400x150,4
Degree of protection	EN 60529:1992		IP65

Characteristics

Glass top plate allows recording of contact surface, wide measuring range, excellent measuring accuracy, excellent accuracy of center of pressure (COP), threshold F_z <250 mN.

Application

This force plate is designed for special gait and balance analysis applications. The glass plate allows simultaneous force measurement and photographic or cinematographic recording of the contact surface from below.

Accessories

Cable Type 1758A...
see data sheet for further details

Data sheet 9285BA_000-743

Multicomponent Force Plate

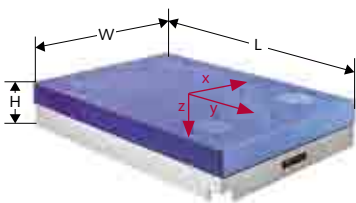

Type 9253B...

Technical Data			Type 9253B11/12	Type 9253B21/22	Type 9253B23
Measuring range	F_x, F_y	kN	-10 ... 10	-15 ... 15	-12 ... 12
	F_z	kN	-10 ... 20	-15 ... 30	-12 ... 25
Overload	F_x, F_y	kN	-15/15	-20/20	-15/15
	F_z	kN	-15/30	-20/40	-15/30
Linearity	%FSO		<±0,5	<±0,5	<±0,5
Hysteresis	%FSO		<0,5	<0,5	<0,5
Crosstalk	$F_x \leftrightarrow F_y$	%	<±2	<±2	<±2
	$F_x, F_y \rightarrow F_z$	%	<±2	<±2	<±2
	$F_z \rightarrow F_x, F_y$	%	<±2	<±2	<±2
Rigidity	x-axis ($a_y = 0$)	N/μm	≈625	≈750	≈850
	y-axis ($a_x = 0$)	N/μm	≈650	≈850	≈750
	z-axis ($a_x = a_y = 0$)	N/μm	≈250	≈450	≈250
Natural frequency	$f_n(x, y)$	Hz	≈800, ≈750	≈580, ≈550	≈610, ≈570
	$f_n(z)$	Hz	≈850	≈720	≈570
Operating temperature range		°C	-20 ... 70	-20 ... 70	-20 ... 70
Weight		kg	40	90	85
Dimensions	LxWxH	mm	600x400x100	600x400x100	600x400x100
Degree of protection	EN 60529:1992		IP67	IP67	IP67

Characteristics

Heavy-duty aluminum or steel cover plate (plain, with tapped holes or with T-slots), waterproof, very wide measuring range.

Application

Special applications under more difficult conditions: immersed in water, with heavy loads, problematic ambient conditions etc.

Accessories

Connection cable
Type 1677AQ02sp
Charge amplifier Type 9865E...
see data sheet for further details

Data sheet 9253B_000-146

Measuring

Quattro Jump, Portable Force Plate System

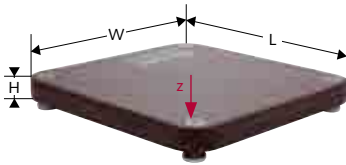

Type 9290BA

Technical Data			Type 9290BA
Measuring range	F_z	kN	0 ... 10
Overload	F_z	kN	15
Linearity	%FSO		<±0,5
Hysteresis	%FSO		<1
Natural frequency	$f_n(z)$	Hz	≈150
Operating temperature range		°C	0 ... 50
Weight		kg	21,6
Dimensions	LxWxH	mm	920x920x125
Sampling rate		Hz	500
Resolution	range 1	N/bit	1
	range 2	N/bit	9,2
Interface to the computer			
Connector type			USB
Power supply			via USB
Degree of protection			EN 60529:1992
			IP50

Characteristics

User-friendly, portable usage, integral charge amplifier and digitization

Application

Objective measurement of jump force, jump height and jump power, immediate feedback to optimize the training program.

Accessories

None

Data sheet 9290BA_000-935

Hand Force Measuring System

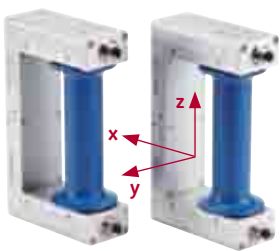

Type 9809A



Technical Data			Type 9809A
Dimensions	WxHxD	mm	50x112x190
Distance of handle axis from mounting surface		mm	80
Width of handle recess		mm	130
Provision for mounting two threaded holes			M8
hole spacing		mm	150
Weight		kg	1,32
Measuring range	F_x, F_y	kN	±1
	F_z	kN	±0,5
Overload capacity	F_x, F_y	kN	-2/2
	F_z	kN	10
	M_z	N·m	15
Linearity		%FS	<±2
Hysteresis		%FS	<0,5
Operating temperature range		°C	0 ... 50
Degree of protection	EN60562		IP64

Characteristics

Complete measuring chain with data acquisition and software. Very easy to use in both laboratory and field.

Application

Used to accurately record the separate hand forces for evaluating mechanical loads and stresses on the body in the area of ergonomics.

Accessories

None

Data sheet 9809A_000-804

Amplifying

Amplifier

8-channel Charge Amplifier



Technical Data			Type 9865E...
Number of measuring channels			8
Measuring ranges	range 1	pC	±1 000
	range 2	pC	±5 000
	range 3	pC	±10 000
	range 4	pC	±50 000
Output voltage (selectable)		V	±5/±10
Output current		mA	<±5
Output impedance		Ω	10
Upper cut-off frequency		kHz	≈10
Lower cut-off frequency			
ranges 1 000 / 5 000 pC		s	≈10
ranges 10 000 / 50 000 pC		s	≈100
Error (all channels)		%FS	<1
Noise (at output)		mV _{rms}	<2
Drift		pC/s	<±0,07
Connections			
Measuring input			Fischer socket, 9 pin
Outputs (analog)			D-Sub 15 pin, female
Inputs (digital, TTL-S)			D-Sub 9 pin, female
Power line (protection class I)			
Power line voltage (switchable)		VAC	230/115
Tolerance		%	-22/15
Frequency		Hz	48 ... 62
Power consumption		VA	≈25
Operating temperature range		°C	0 ... 50
Dimensions		WxHxD	mm 236x151x225
Weight		kg	≈4
Degree of protection			
Electro-medical equipment			EN 60601-1, EN 60601-1-2
Safety requirements			EN 61010-1
EMC emission			EN 50081-1
EMC immunity			EN 50082-1

Characteristics

8-channel charge amplifier with 4 measuring ranges, remote controlled.

Application

Universal, economically priced multichannel charge amplifier for Kistler force plates.

Accessories

Connection cable Type 1677A...
 Connection cable Type 1681B...
 Connection cable Type 1685B...
 Connection cable Type 1686A...
 BioWare® Type 2812A
 see data sheet for further details

Data sheet 9865E_000-287

Control Unit



Technical Data			Type 5233A2
Number of measuring channels			8
Output signal		V	-10 ... 10
Connections			
Connection to force plate			MIL 1419 (19 pin)
Connection to PC (remote control)			D-Sub 37 female
Analog outputs			BNC female
Power (2 phases + ground)			IEC 320 C14
Power line, switchable		V AC	230/110
Power line frequency		Hz	48 ... 60
Dimensions		WxHxD	mm 170x126x55

Properties

External control unit for measuring components with built-in charge amplifier.

Areas of application

Manual control of Kistler multicomponent force plates with analog signal output.

Accessories

Connection cable Type 1757A10
 Connection cable Type 1760A10
 see data sheet for further details

Data sheet 5233A_000-150

Software

16ch DAQ System for BioWare®



Technical Data			Type 5691A1
Dimensions	WxHxD	mm	208x65x250
Weight (total)		kg	2,05
Operating temperature range		°C	0 ... 50
Power supply voltage			
Power supply		VDC	11 ... 15
Power consumption		VA	6
AD converter			
Number of channels			16
Resolution (per channel)		Bit	16
Sampling rate		S/s	0,6 ... 50 000 (software selectable)
1 Force plate	max. @ 8 channels	kS/s	17
2 Force plates	max. @ 16 channels	kS/s	9,5
Connections USB 2.0			
USB In (uplink, to the PC)			USB Type B, female
USB Out (downlink, free)			USB Type A, female
Force plate 1/2			
Input voltage range (max.)		V	±15
External trigger		Type	BNC female

Characteristics

USB 2.0 ensures easy installation, remote control with integral charge amplifier, Powerful data acquisition and signal processing system, versatile data analysis and filter, external and internal trigger. Includes BioWare® software.

Application

Suitable for measuring both slow and highly dynamic processes as well as very small measurands. Suitable for basic research, sports science, gait analysis, ergonomics, etc.

Accessories

Connection cable Type 1758A...
 Connection cable Type 1759A...
 Connection cable Type 1791A...
 BioWare® Type 2812A...
 see data sheet for further details

Data sheet 5691A_000-633

64ch DAQ System for BioWare®



Technical Data			Type 5695A
Dimensions	WxHxD	mm	208x70x265
Weight		kg	2,3
Operating temperature range		°C	0 ... 50
Power supply voltage			
Power supply		VDC	10 ... 36
Power consumption max.		VA	<10
A/D converter			
Number of channels			64
Resolution (per channel)		Bit	16
Sampling rate max.		S/s	10 000
Control I/O			
Trigger Input/Sync Input	High	VDC	>2,3
	Low	VDC	<1
Trigger Output/Sync Output/Sampling Clock Output/Reserve Output			
High @Iout = 10 µA/2 mA		VDC	>4,9/>4,4
Low @Iout = 10 µA/2 mA		VDC	<0,1/<0,35
Connections			
USB In (uplink to the PC)			USB 2.0 USB Type B, female
Force Plate 1 ... 8			
Power supply per force plate		VDC	12
Supply current (max.)		mA	50

Characteristics

Data acquisition system for connecting/controlling up to 8 multicomponent force plates with integral charge amplifiers. Remote control of integral charge amplifiers; Powerful data acquisition and signal processing; Versatile digital control and synchronization options.

Application

Ideal for measuring highly dynamic processes, very small measurands and slow phenomena. The additional options of acquiring any analog signals and the versatile digital control and synchronization options underscore the versatility of the system.

Accessories

Connecting cable Type 1700A105A...
 Connecting cable Type 1700A107A...
 Connecting cable Type 1700A109A...
 Connecting cable Type 1779A
 Adapter box Type 5767
 see data sheet for further details

Data sheet 5695A_000-803

Analysis

Software

BioWare® Type 2812A



Characteristics

Very versatile, easy to use Windows® software specially designed to work with Kistler force plates in the various fields of biomechanics:

- Biomechanics research
- Gait analysis (rehabilitation, orthopaedics, prosthetics)
- Sports (jump force, impact, training)
- Neurology (posturography, balance, microvibrations)
- Ergonomics, industry (shoe development, material testing, safety, loading)

BioWare contains all data acquisition, signal conditioning and analysis of force plate data.

Application

Suitable for use in basic research, gait analysis, sports, neurology, ergonomics and industry.

Can be used with all Kistler data acquisition systems.
Includes Dataserver.dll (Type 2873).

Accessories

BioWare® data acquisition system	Type 2812A
16ch DAQ system	Type 5691A...
64ch DAQ system	Type 5695A...

see data sheet for further details

Data sheet 2812A_000-370

Windows® is a registered trademark of Microsoft Corporation

BioWare® DataServer.dll, Type 2873



Characteristics

The DataServer Interface Library [DataServer.dll] is a Microsoft Component Object Model in-process server. The Microsoft® Component Object Model (COM) is a software architecture that allows applications to be built from binary software components.

.COM ensures the interoperability of the components across many software development languages (C++, Visual Basic, Java, etc.) by providing a binary standard for component development.

Application

The DataServer Interface Library is intended to provide 3rd party integrators with a simple, high level interface to the Kistler force platform data through the 5691A... and 5695A... DAQ system. The DataServer COM components are available to manage the force platforms and auxiliary devices and to provide typical force platform calculated data streams.

The intent is for 3rd party integrators to provide a simple XML configuration file, and then use the internal data acquisition and calculations using any COM compatible language.

Accessories

16ch DAQ system	Type 5691A...
64ch DAQ system	Type 5695A...

BioWare DataServer.dll can be downloaded free of charge from the Kistler website (www.kistler.com).

Microsoft® is a registered trademark of Microsoft Corporation

Wise Coach, Type 2875



Characteristics

Wise Coach is a routine diagnostics and research software for Kistler force plates and data acquisition systems in biomechanics, performance analysis, motor control and rehabilitation medicine. The acquired force plate signals are analyzed and the calculated parameters and graphical presentations of the measurements can be reported and exported. Wise Coach creates and manages a database with all entered and acquired data.

Application

Wise Coach includes several measurement modules to evaluate the physical performance of a subjects in the field of power, coordination, balance and anaerobic endurance. The testing procedures and the calculations of the observed parameters are based on scientific needs as well as on routine diagnostics. Besides the standard parameters, many other evidence-based parameters are calculated for all single tests to provide most detailed information instantly.

Accessories

16ch DAQ system	Type 5691A...
64ch DAQ system	Type 5695A...

Data sheet 2875_000-936

Connecting

Connection Cables

Cables



Technical Data		Type 1681B...
Connection		Fischer 9 pin male – Fischer 9 pin male
Length	m	5/10/20
Diameter	mm	12,3
Degree of protection (EN 60529)		IP65



Technical Data		Type 1685B...
Connection		Fischer 9 pin male – Fischer 9 pin male
Length	m	5/10/sp (max. 20)
Diameter	mm	5,6
Degree of protection (EN 60529)		IP65



Technical Data		Type 1686A...
Connection		Fischer angle 9 pin male – Fischer 9 pin male
Length	m	5/10/sp (max. 20)
Diameter	mm	5,6
Degree of protection (EN 60529)		IP65



Technical Data		Type 1757A...
Connection		Fischer angle 19 pin male – MIL 19 male
Length	m	10/sp (max. 30)
Diameter	mm	5,6
Degree of protection (EN 60529)		IP63



Technical Data		Type 1758A...
Connection		Fischer 19 pin male – D-Sub 37 female
Length	m	10/sp (max. 30)
Diameter	mm	8
Degree of protection (EN 60529)		IP63



Technical Data		Type 1759A...
Connection		Fischer angle 19 pin male – D-Sub 37 female
Length	m	10/sp (max. 30)
Diameter	mm	8
Degree of protection (EN 60529)		IP63



Technical Data		Type 1760A...
Connection		Fischer 19 pin male – MIL 19 male
Length	m	10/sp (max. 30)
Diameter	mm	8
Degree of protection (EN 60529)		IP63



Technical Data		Type 1700A105A...
Connection		Fischer 19 pin male – D-Sub 25 pin male
Length	m	10/sp (max. 30)
Diameter	mm	8
Degree of protection (EN 60529)		IP63

Connecting

Connection Cables

Cables



Technical Data		Type 1700A105B...
Connection		Fischer 19 pin male – D-Sub 25 pin male
Length	m	10/sp
Diameter	mm	8
Degree of protection (EN 60529)		IP63



Technical Data		Type 1700A107A...
Connection		D-Sub 25 pin male – D-Sub 25 pin male
Length	m	10/sp
Diameter	mm	8
Degree of protection (EN 60529)		IP50



Technical Data		Type 1700A109A...
Connection		D-Sub 37 pin male – D-Sub 25 pin male
Length	m	2/sp
Diameter	mm	8
Degree of protection (EN 60529)		IP50



Technical Data		Type 1791A...
Connection		D-Sub 25 pin male – D-Sub 37 pin female
Length	m	10/sp
Diameter	mm	8
Degree of protection (EN 60529)		IP50



Technical Data		Type 1793A...
Connection		D-Sub 25 pin male – MIL 19 male
Length	m	10/sp
Diameter	mm	8
Degree of protection (EN 60529)		IP50



Technical Data		Type 1769A...
Connection		D-Sub 9 pin female – D-Sub 37 pin female D-Sub 12 pin female – D-Sub 37 pin female
Length	m	1/sp
Diameter	mm	6,2/4,9
Degree of protection (EN 60529)		IP50



Technical Data		Type 1779A...
Connection		D-Sub 9 pin female – D-Sub 25 pin male D-Sub 12 pin female – D-Sub 25 pin male
Length	m	2
Diameter	mm	8
Degree of protection (EN 60529)		IP50



Technical Data		Type 5767
Connection		D-Sub 9 pin male – BNC female
Length	m	0,4
Diameter	mm	4,9
Degree of protection (EN 60529)		IP50

Accessories

Installation Options

Mounting Frames

Mounting frames for a permanent flush installation in the floor:

- Type 9423 Mounting frame for Type 9281...
- Type 9427 Mounting frame for Type 9287...

Different mounting frames for multiple force plate installations are available on request.



For Type 9260AA...

- Type 9428A1 Mounting frame for 4 x Type 9260A6 (2x2 Matrix)
- Type 9428A2 Mounting frame for 2 x Type 9260AA6 longitudinal
- Type 9428A3 Mounting frame for 2 x Type 9260AA6 transversal
- Type 9428A5 Mounting frame for 1 x Type 9260AA6 and 1 x Type 9260AA3 longitudinal
- Type 9428A6 Mounting frame for Type 9260AA6 or 2 x Type 9260AA3
- Type 9428AF Set of 4 mounting feet for frame Type 9260AA...

Walkways

Walkway elements for installation of portable force plates on the floor:

Walkway elements for Type 9260AA...

- Type 9418A1 Walkway ramp, 500x300 mm
- Type 9418A2 Walkway ramp, 600x300 mm
- Type 9418A3 Force plate dummy, 300x500 mm
- Type 9418A4 Walkway according 3 x Type 9260AA6 longitudinal, 1 806x500 mm
- Type 9418A5 Force plate dummy, 300x250 mm
- Type 9418A6 Force plate dummy, 600x500 mm
- Type 9418A7 Walkway according 2 x Type 9260AA6 longitudinal, 1 203x500 mm
- Type 9418A8 Walkway according 2 x Type 9260AA6 transversal, 1 003x600 mm

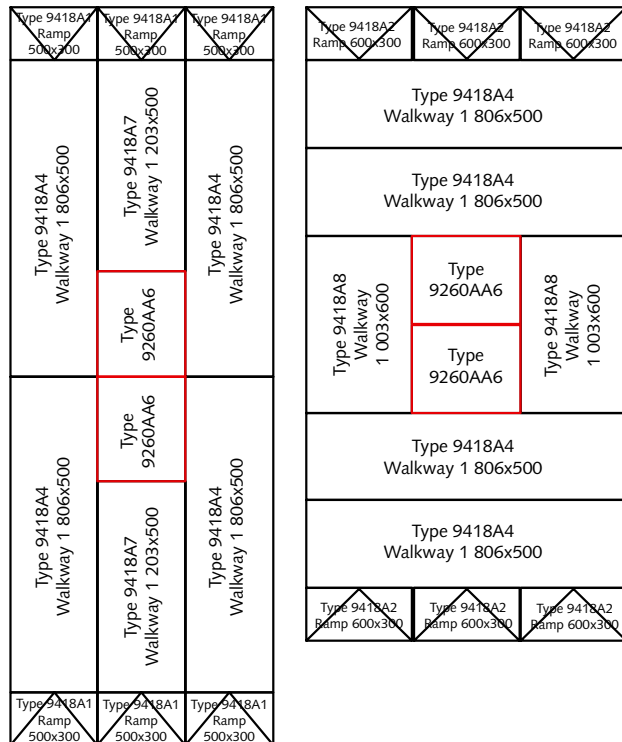

Walkway elements for Type 9286BA...

- Type 9401C1 Walkway central piece 800x1 200x35 mm
- Type 9401C2 Walkway extension piece 620x1 200x35 mm
- Type 9401C3 Walkway intermediary 200x1 200x35 mm
- Type 9401C4 Walkway ramp 630x1 200x35 mm

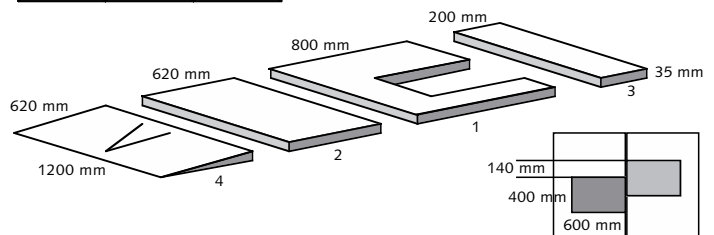

Why Kistler Force Plates?

The unique piezoelectric measuring system offers numerous advantages over force plates with strain gages, and makes Kistler force plates a cost-effective investment for biomechanical and medical laboratories.

Advantages of Kistler force plates

- Extremely wide measuring range and excellent resolution
- One and the same force plate covers broad range of applications
- High overload protection and virtually no deterioration with age

Kistler guarantees reliable specifications and calibration

- High accuracy, linearity and sensitivity
- High natural frequency and damping
- Worldwide sales and customer service network

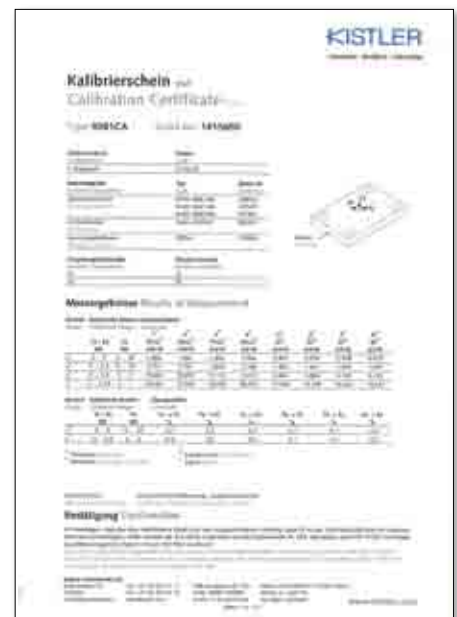
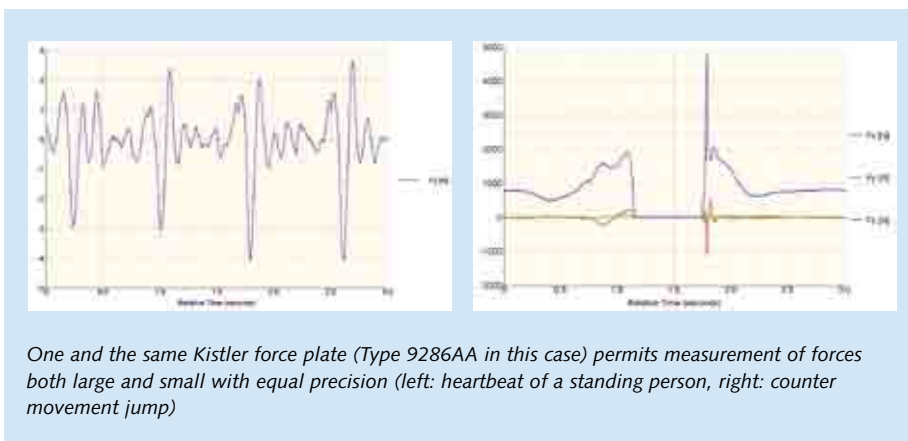
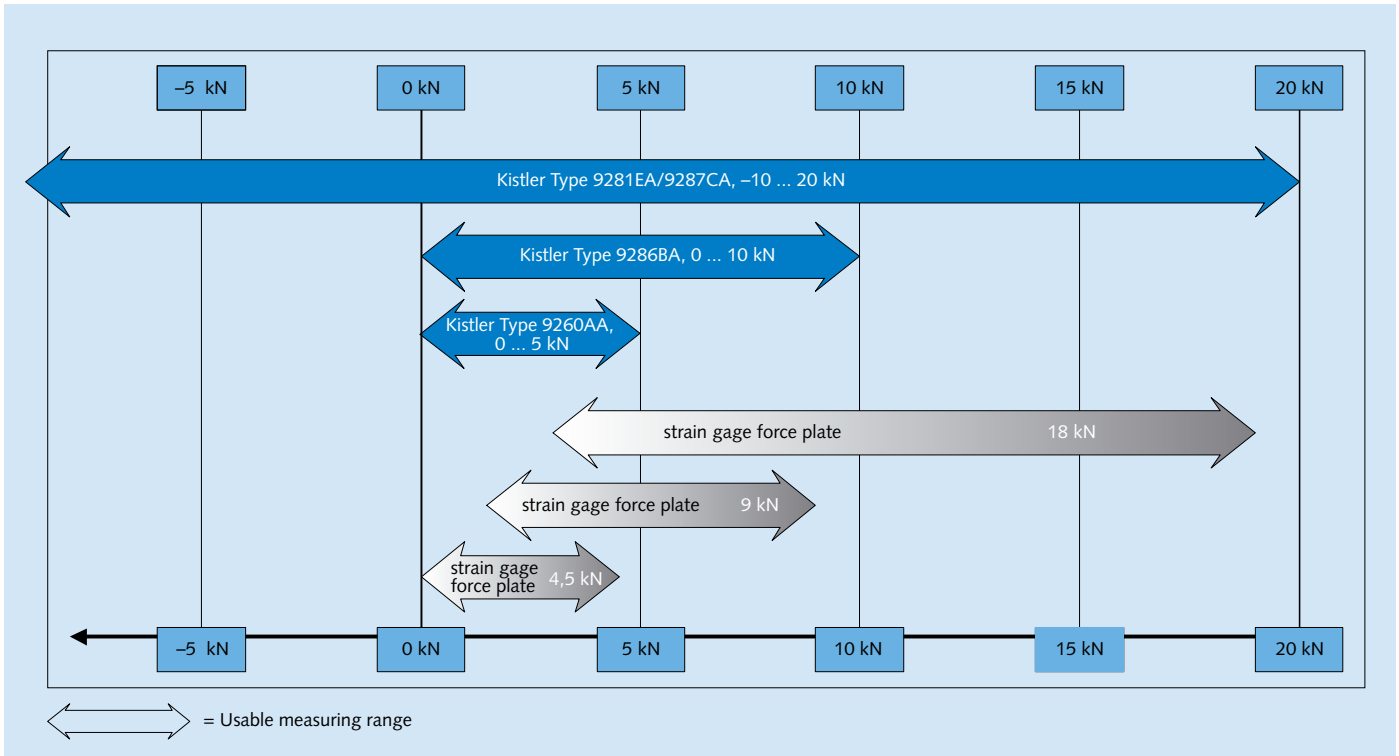

Kistler Worldwide

Europe

Austria

Kistler GmbH
Lemböckgasse 49f
1230 Wien
Tel. +43 1 867 48 67 0
sales.at@kistler.com

Czech Republic/Slovakia

Kistler, s.r.o.
Zelený pruh 99/1560
140 00 Praha 4
Tel. +420 296 374 878
sales.cz@kistler.com

Denmark

Kistler Nordic DK
Grønlandsvej 4
4681 Herfølge
Tel. +45 70 20 85 66
info.dk@kistler.com

Finland

Kistler Nordic AB
Särkiniementie 3
00210 Helsinki
Tel. +358 9 612 15 66
info.fi@kistler.com

France

Kistler France
ZA de Courtabœuf 1
15, avenue du Hoggar
91953 Les Ulis cedex
Tel. +33 1 69 18 81 81
info.fr@kistler.com

Germany

Kistler Instrumente GmbH
Daimlerstrasse 6
73760 Ostfildern
Tel. +49 711 34 07 0
info.de@kistler.com

Italy

Kistler Italia s.r.l.
Via Ruggero di Lauria, 12/B
20149 Milano
Tel. +39 02 481 27 51
sales.it@kistler.com

Netherlands

Kistler B.V. Nederland
Leeghwaterstraat 25
2811 DT Reeuwijk
Tel. +31 182 304 444
sales.nl@kistler.com

Spain

Kistler Ibérica S.L, Unipersonal
C/Pallars, 6 Planta 2
08402 Granollers
Barcelona
Tel. +34 93 860 33 24
info.es@kistler.com

Sweden/Norway

Kistler Nordic AB
Aminogatan 34
431 53 Mölndal
Tel. +46 31 871 566
info.se@kistler.com

Switzerland/Liechtenstein

Kistler Instrumente AG
Eulachstrasse 22
8408 Winterthur
Tel. +41 52 224 12 32
sales.ch@kistler.com

United Kingdom

Kistler Instruments Ltd.
13 Murrell Green Business Park
Hook, Hampshire RG27 9GR
Tel. +44 1256 74 15 50
sales.uk@kistler.com

Asia

China, People's Republic of Kistler China Ltd.

Unit D, 24/F Seabright Plaza
9-23 Shell Street North Point
Hong Kong
Tel. +852 25 915 930
sales.cn@kistler.com

India

Kistler Instruments (India) Pvt .Ltd.
TA-3,3rd floor, Crown Plaza,
Sector-15 A, Faridabad - 121 007
Haryana/India
Tel. +91 129 4113 555
sales.in@kistler.com

Japan

Kistler Japan Co., Ltd.
1F Yokoso Rainbow Tower
3-20-20, Kaigan, Minato-ku
Tokyo 108-0022
Tel. +81 3 3769 9501
sales.jp@kistler.com

Korea, Republic of

Kistler Korea Co., Ltd.
Gyeonggi Venture Anyang
Technical College Center 410
572-5, Anyang-Dong, Manan-Gu,
Anyang-City, Gyeonggi-Do 430-731
Tel. +82 31 465 6013
sales.kr@kistler.com

Singapore

Kistler Instruments (Pte) Ltd.
50 Bukit Batok Street 23
#04-06 Midview Building
Singapore 659578
Tel. +65 6316 7331
sales.sg@kistler.com

Taiwan

Kistler Instrumente AG, Taiwan Branch
5F.-17, No. 6, Lane 180
Sec. 6, Mincyuan E. Road
Taipei 114
Tel. +886 2 7721 2121
sales.tw@kistler.com

Thailand

Kistler Instrument (Thailand) Co., Ltd.
26/56 TPI Tower, 20th Floor
Nanglingee Rd., (Chan Tat Mai Rd.)
Thungmahamek, Sathorn
Bangkok 10120
Tel. +66 2678 6779-80
sales.thai@kistler.com

America

USA/Canada/Mexico

Kistler Instrument Corp.
75 John Glenn Drive
Amherst, NY 14228-2171
Tel. +1 716 691 5100
sales.us@kistler.com

Australia

Australia

Kistler Instruments Australia Pty Ltd
Unit 1.23/202 Jells Rd.
Wheeler's Hill, Victoria 3150
Tel. +61 3 9560 5055
sales.au@kistler.com

Other Countries

Kistler Instrumente AG

Export Sales
Eulachstrasse 22, 8408 Winterthur
Switzerland
Tel. +41 52 224 11 11
sales.export@kistler.com

www.kistler.com

KISTLER

measure. analyze. innovate.

Headquarters

Switzerland

Kistler Group
Eulachstrasse 22, 8408 Winterthur
Tel. +41 52 224 11 11
Fax +41 52 224 14 14
info@kistler.com